



Universiteit
Leiden
The Netherlands

Shock waves through inhomogeneous media

Lukkezen, J.; Rademaker, L.

Citation

Lukkezen, J. ; R. , L. (2006). *Shock waves through inhomogeneous media*.

Version: Not Applicable (or Unknown)

License: [License to inclusion and publication of a Bachelor or Master thesis in the Leiden University Student Repository](#)

Downloaded from: <https://hdl.handle.net/1887/3596892>

Note: To cite this publication please use the final published version (if applicable).

Shock waves through inhomogeneous media

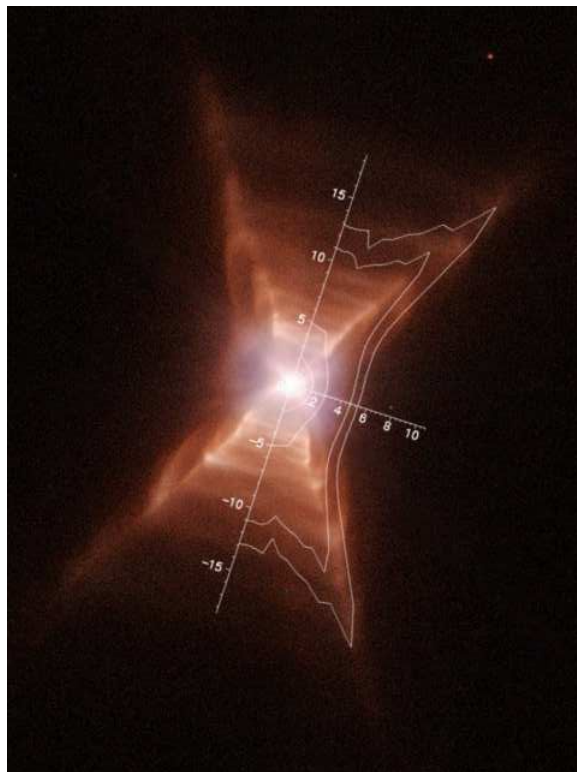

Jasper Lukkezen and Louk Rademaker

September 21, 2006

Abstract

Planetary nebulae (PN) often have weird shapes, due to an inhomogeneous interstellar medium. We investigated the propagation of the shock wave that forms a PN. The form of the shock wave depends on the initial density distribution. The equation that describes the shock propagation is a first order non-linear partial differential equation. We found an analytic solution for the equation after certain assumptions for some basic functions and made estimations for more complex density functions. We also made a model that used toroidal coordinates and one in three dimensions. The toroidal model resembles the Red Rectangle nebula.

We also inverted the two-dimensional equation with some assumptions to derive the initial density function from a known shock wave. We used a numerical model to compute the density profile for eleven known planetary nebulae. This leads to a qualitative classification into the ellipsoidal, disk and irregular nebulae. Inserting some test shock waves into this equation shows the existence of an extraordinary clover-like shape in the density function.

Contents

| | | |
|----------|--|-----------|
| 1 | Introduction | 3 |
| 1.1 | Astrophysical background | 3 |
| 1.2 | Mathematical background | 4 |
| 1.3 | Short overview | 5 |
| 2 | Basic Theory of Shock Waves | 6 |
| 2.1 | The equation of motion | 6 |
| 2.2 | Shock wave geometry in 2 dimensions | 8 |
| 2.3 | Constructing the PDE | 10 |
| 2.4 | Generalization for 3 dimensions | 11 |
| 3 | Known work | 13 |
| 3.1 | Kompaneets (1960) | 13 |
| 3.2 | Icke (1988) | 18 |
| 4 | Given A, what is r? | 22 |
| 4.1 | Constant A | 22 |
| 4.2 | A proportional to r^2 | 24 |
| 4.3 | Solutions for $A \propto r^2 A(\theta)$ | 24 |
| 4.3.1 | Linear density | 25 |
| 4.3.2 | Quadratic density | 28 |
| 4.3.3 | Physical profiles | 41 |
| 4.4 | Toroidal Coordinates | 43 |
| 4.4.1 | Transformation to Euclidean coordinates | 43 |
| 4.4.2 | Transformation to Polar coordinates | 46 |
| 4.4.3 | A possible function for A | 47 |
| 4.4.4 | Numerical approximation | 47 |
| 4.4.5 | Red Rectangle | 48 |
| 4.4.6 | Final comment on Toroidal coordinates | 51 |

| | | |
|----------|--|-----------|
| 4.5 | K independent of r in 3 dimensions | 51 |
| 4.6 | What if $r \rightarrow \infty$? | 53 |
| 5 | Given r, what was ρ? | 56 |
| 5.1 | Theory: The other way around | 56 |
| 5.2 | Test functions | 57 |
| 5.3 | Numerical models | 57 |
| 6 | Conclusion and Discussion | 61 |
| 6.1 | Summary | 61 |
| 6.2 | Discussion | 62 |
| A | Theory of Envelopes | 65 |
| A.1 | The Monge Cone | 65 |
| A.2 | Envelopes | 66 |
| A.3 | Complete integral | 67 |
| A.4 | Basic Theory on First Order PDE's | 68 |
| A.5 | System of CDE for Kompaneets equation | 69 |
| B | Maple program used to construct the complete integral | 71 |
| C | IDL-Program for numerical modeling | 73 |
| C.1 | Information | 73 |
| C.2 | Analyse shock front and calculate A^* | 74 |
| D | Images of Planetary Nebulae | 81 |
| D.1 | The Red Rectangle | 87 |

Chapter 1

Introduction

1.1 Astrophysical background

The astrophysical background which is described shortly here can be found extensively in for example [Carroll & Ostlie, 1995].

When a star burns hydrogen into helium during its stay on the main sequence of the Hertzsprung-Russell diagram it is in thermo- and hydrodynamic equilibrium. The Hertzsprung Russell diagram, figure (1.1) plots the surface temperature (and thereby their color) against their luminosity. The pressure generated by nuclear fusion in the interior is opposed by the gravitational pressure. This equilibrium means that when the nuclear fusion rate rises, more energy or outward pressure is generated and the star will expand, causing a drop in the temperature and an immediate decrease in the fusion rate, which will in turn make sure that the star gets a little smaller. However, when the hydrogen is exhausted in a low mass star, the star will contract until it reaches a temperature high enough to burn helium into carbon. The stellar core will contract further and form a white dwarf after all the helium in the central core is exhausted.

What happens to the core is a very interesting research topic, which however we will not be discussing any further here. We are concerned with what exactly happens to the stellar atmosphere.

During its helium burning phase the star produces a lot more energy than during the hydrogen burning phase, mostly in form of shock waves. These shock waves start at the core, where the helium fusion takes place. Then they travel through the star and blow off the stellar atmosphere. After that, the shock waves travel through the interstellar space surrounding the star. It is the propagation of these shock waves we are interested in. The

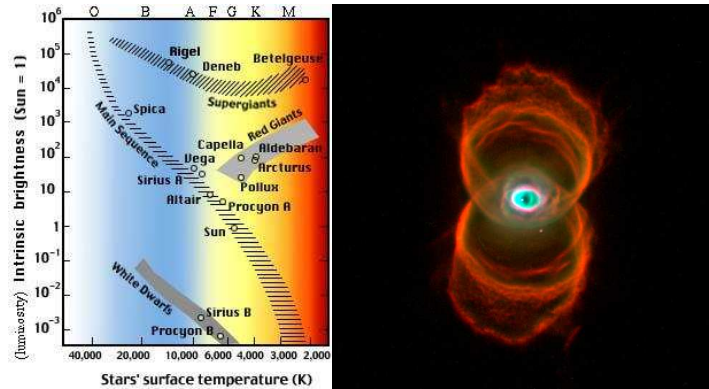

Figure 1.1: Left: *The Hertzsprung Russell diagram. In this diagram all stars are assigned a place according to their luminosity and their surface temperature. The main sequence is the broad diagonal band from the top left to the bottom right of the diagram. Planetary nebula are found around white dwarfs (at the bottom of the diagram) and are formed from low massive stars on the bottom right of the main sequence.* Right: *Hourglass Nebula, picture taken by the hubble space telescope.*

nebula created by these waves are called planetary nebula and they make the nicest astronomical pictures that are available. Look at figure (1.1) for an example.

Basically one would expect these spherically symmetric shock waves to form a spherically symmetric increasing bubble surrounding the star. However, in most cases, observations show that these shock waves create ellipsoïds or even hour glasses as nebula. This is most probably caused by an inhomogeneity in the density of the pressure of the interstellar gas where the shock waves travel through.

1.2 Mathematical background

The equation that describes the shape of the shock wave is a nonlinear first order partial differential equation. We are going to derive that equation from the physical situation. This equation cannot be solved generally. Only in some cases it can be integrated by separation of variables. After that we need a boundary condition to get rid of the integration constant. Unfortunately we found it very hard to do it analytically for solutions other than the exponential one already found by [Kompaneets, 1960]. We will explain why

it is that hard to find the solution by direct computation.

However, with the theory of envelopes it is possible to construct an envelope of partial solutions, which we will call partial waves, which give us when added up the physical relevant solution (namely the shape of the shock wave). Every partial wave is by itself a solution of our partial differential equation. With this theory it is possible to give solutions to a much broader set of functions.

1.3 Short overview

We will shortly explain the basic theory of shock waves in section **2** and review the results obtained in earlier work on this subject by [Icke, 1988] and [Kompaneets, 1960] in section **3**. After that we will construct different envelopes of partial waves in section **4** to determine the shape of the envelope from a given A . This A is the ratio of the pressure of the shock wave to the density of the material outside the shock wave. Then we will show why we did not succeed in direct computation of the complete integral in most cases as Kompaneets did. In section **5** we will try to determine A - or the initial density - when the shock shape is known. First analytically and after that we will determine it numerically for a few nebula. The backgrounds on the theory of envelopes can be found in the first appendix.

Chapter 2

Basic Theory of Shock Waves

In this section, we will elaborate the physics behind the equation that describes the propagation of shock waves. The differential equation itself will be derived in the 2 and 3 dimensional case.

2.1 The equation of motion

Physically, the propagation of the shock wave is determined by the so-called 'jump conditions'. These conditions are relationships between the pressure, energy, density and motion of the gas ahead of and behind the shock wave. They are based upon the conservation laws.

We define \vec{D} as the velocity vector of the propagation of the shock wave. The surrounding gas has initial velocity \vec{u} . The velocity of the shock wave relative to the gas velocity is thus $\vec{D} - \vec{u}$. Now the jump conditions only depend on the gas flow through the shock, which is the flow perpendicular on the shock wave. The inward flow of gas into the shock wave is thus defined by

$$u_0 = D - u_n \quad (2.1)$$

where u_n is the component of \vec{u} perpendicular on the shock wave. We define u_1 as the flow outward, thus behind, the shock wave. The conservation laws are:

Conservation of mass:

$$\rho_1 u_1 = \rho_0 u_0. \quad (2.2)$$

Conservation of momentum:

$$p_1 + \rho_1 u_1^2 = p_0 + \rho_0 u_0^2. \quad (2.3)$$

Conservation of energy:

$$\epsilon_1 + \frac{p_1}{\rho_1} + \frac{u_1^2}{2} = \epsilon_0 + \frac{p_0}{\rho_0} + \frac{u_0^2}{2}. \quad (2.4)$$

Here ρ is the density, p is the pressure, ϵ is the energy per unit mass and the index 0 indicates the properties before being hit by the shock wave and 1 indicates properties after being hit. See also figure 2.1. Now let us rearrange (2.3) to:

$$u_0^2 = \frac{p_1 - p_0 + \rho_1 u_1^2}{\rho_0}.$$

And make use of (2.2) and the fact that the pressure in the interstellar gas outside of the shock wave can be neglected when compared to the pressure of the gas in the shock wave. In the long term the pressure of the shock wave of a planetary nebula reduces. So the aforementioned assumption only applies to early times. That means $p_1 \gg p_0$ and then u_0^2 becomes to leading order:

$$\begin{aligned} u_0^2 &= \frac{p_1 + \frac{\rho_0^2}{\rho_1} u_0^2}{\rho_0} = \frac{p_1}{\rho_0} + \frac{\rho_0}{\rho_1} u_0^2. \\ u_0^2 &= \frac{\frac{p_1}{\rho_0}}{1 - \frac{\rho_0}{\rho_1}}. \end{aligned} \quad (2.5)$$

We now introduce the specific volume $V_i = \frac{1}{\rho_i}$ and rewrite the last equation:

$$u_0^2 = \frac{1}{\rho_0} \frac{p_1}{\rho_0 \left(\frac{1}{\rho_0} - \frac{1}{\rho_1} \right)} = V_0^2 \frac{p_1}{V_0 - V_1}.$$

The same for u_1 :

$$u_1^2 = V_1^2 \frac{p_1}{V_0 - V_1}.$$

Now we substitute both equations in (2.4) and use the equation for the energy of a gas $\epsilon_1 = c_v T = \frac{1}{\gamma-1} p_1 V_1$. The equation for the energy of a gas used here is the one for a perfect or ideal gas with constant specific heat. This is not a strange assumption, since the densities in interstellar gas (and shock waves) are very low. See for a more detailed explanation [Zel'dovich & Raizer, 2002].

$$\begin{aligned} \frac{1}{\gamma-1} p_1 V_1 + p_1 V_1 + \frac{1}{2} V_1^2 \frac{p_1}{V_0 - V_1} &= \frac{1}{2} V_0^2 \frac{p_1}{V_0 - V_1} \\ \frac{1}{\gamma-1} p_1 V_1 + p_1 V_1 &= \frac{1}{2} \frac{p_1}{V_0 - V_1} (V_0^2 - V_1^2) \end{aligned}$$

$$\begin{aligned} \frac{1}{\gamma-1}p_1V_1 + p_1V_1 &= \frac{1}{2}(p_1)(V_0 + V_1) \\ V_1\left(\frac{1}{\gamma-1}p_1 + p_1 - \frac{p_1}{2}\right) &= V_0\left(\frac{p_1}{2}\right) \\ V_1\frac{\gamma+1}{\gamma-1}p_1 &= V_0p_1 \\ \frac{V_1}{V_0} &= \frac{\gamma-1}{\gamma+1}. \end{aligned}$$

Substituting this in (2.5) gives:

$$u_0^2 = \frac{\frac{p_1}{\rho_0}}{1 - \frac{\gamma-1}{\gamma+1}} = \frac{p_1}{\rho_0} \frac{\gamma+1}{2} \equiv K. \quad (2.6)$$

We can use this result to complete equation (2.1):

$$D = u_n + \sqrt{K}. \quad (2.7)$$

This equation describes the physical background of the shock wave.

2.2 Shock wave geometry in 2 dimensions

In 2-dimensional polar coordinates, the shock wave can be described by the formula $r = r(\theta)$. A drawing of this curve can be seen in figure 2.1. In general, however, a curve is defined by $\vec{r}(t)$ with the curve parameter t . Because we are interested in a function of the form $r(\theta)$, we must choose $\theta(t) = t$. Now our goal is to define the shock velocity vector \vec{D} in terms of $r(\theta)$.

From figure 2.1 we know that \vec{D} is perpendicular to the tangent vector of $r(\theta)$. An infinitesimal small interval $\Delta\vec{r}$ on the curve $\vec{r}(t)$ is equal to $\Delta r \hat{r} + r\Delta\theta \hat{\theta}$, where the hat denotes a unit vector. We can make a tangent vector \vec{T} on the curve:

$$\vec{T} = \frac{\partial r}{\partial t} \hat{r} + r \frac{\partial \theta}{\partial t} \hat{\theta}.$$

Because $\theta = t$ in this case, we get

$$\vec{T} = \frac{\partial r}{\partial \theta} \hat{r} + r \hat{\theta}.$$

The vector perpendicular to this tangent is the shock velocity \vec{D} , which can be written as $D_r \hat{r} + D_\theta \hat{\theta}$. According to standard linear algebra, the scalar product of two perpendicular vectors must be zero: $\vec{D} \cdot \vec{T} = 0$. This yields

$$\frac{\partial r}{\partial \theta} D_r + r D_\theta = 0.$$

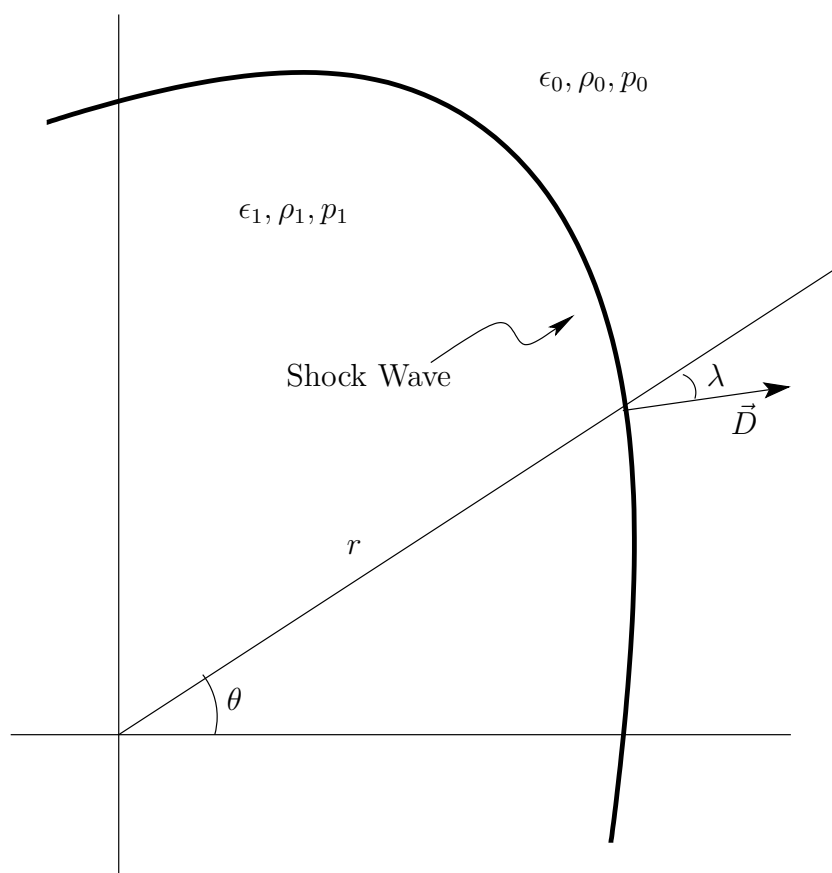

Figure 2.1: *The shock wave with its parameters r and θ . The shock velocity vector \vec{D} is perpendicular to the tangent of the shock wave. The energy density is denoted by ϵ , the pressure by p and the mass density by ρ . The index 0 indicates the gas ahead of the shock, the index 1 the gas behind the shock wave.*

We define λ as the angle between D and \hat{r} (see figure 2.1). Now by definition $\tan \lambda = D_\theta/D_r$. This leads to the conclusions that

$$\tan \lambda = -\frac{1}{r} \frac{\partial r}{\partial \theta}. \quad (2.8)$$

The radial component of the shock velocity vector is now equal to $\frac{\partial r}{\partial t}$:

$$|D| = \frac{\partial r}{\partial t} \cos \lambda. \quad (2.9)$$

In the 2-dimensional polar case the velocity of the surrounding cloud perpendicular to the shock wave u_n can be decomposed in a radial and a polar component.

$$u_n = u_r \cos \lambda + u_\theta \sin \lambda. \quad (2.10)$$

Here u_r and u_θ are the radial and polar components of the velocity of the external cloud.

2.3 Constructing the PDE

To construct the partial differential equation for the shock wave propagation, we must combine the geometric properties (2.9) and (2.10) and the physical property of the shock velocity (2.7). We obtain

$$D = \frac{\partial r}{\partial t} \cos \lambda = u_r \cos \lambda + u_\theta \sin \lambda + \sqrt{\mathbf{K}}.$$

Now we divide by $\cos \lambda$ and make use of $\frac{1}{\cos^2 \lambda} = 1 + \tan^2 \lambda$ and (2.8):

$$\frac{\partial r}{\partial t} = u_r - u_\theta \frac{1}{r} \frac{\partial r}{\partial \theta} + \left\{ \mathbf{K} \left[1 + \left(\frac{1}{r} \frac{\partial r}{\partial \theta} \right)^2 \right] \right\}^{\frac{1}{2}}.$$

When we take $\mathbf{K} = A$ to be prescribed and $u = u_r$ (a good assumption when the gas cloud where the shock wave travels through is caused by gas previously emitted by the central star) this reduces to:

$$\frac{\partial r}{\partial t} = u_r + \left\{ A \left[1 + \left(\frac{1}{r} \frac{\partial r}{\partial \theta} \right)^2 \right] \right\}^{\frac{1}{2}}. \quad (2.11)$$

2.4 Generalization for 3 dimensions

In 3 dimensions, we are no longer working with a curve describing the shock front. It is now a surface $r(\theta, \phi)$, and so we must construct two tangents: one along θ and one along ϕ . The interval can now be formulated by $(\Delta r) \hat{r} + r(\Delta\theta) \hat{\theta} + r \sin(\theta)(\Delta\phi) \hat{\phi}$. The two corresponding tangents are now:

$$T_\theta = \frac{\partial r}{\partial \theta} \hat{r} + r \hat{\theta}.$$

$$T_\phi = \frac{\partial r}{\partial \phi} \hat{r} + r \sin \theta \hat{\phi}.$$

By definition is λ the angle between \vec{D} and the radius vector. This means that $\tan^2 \lambda = (D_\theta/D_r)^2 + (D_\phi/D_r)^2$. Because $\vec{D} \cdot \vec{T}_\theta = \vec{D} \cdot \vec{T}_\phi = 0$, we can derive in a similar fashion

$$\frac{D_\theta}{D_r} = -\frac{1}{r} \frac{\partial r}{\partial \theta}.$$

and

$$\frac{D_\phi}{D_r} = -\frac{1}{r \sin \theta} \frac{\partial r}{\partial \phi}.$$

Which leads to the conclusion that

$$\tan \lambda = \sqrt{\left(\frac{1}{r} \frac{\partial r}{\partial \theta}\right)^2 + \left(\frac{1}{r \sin \theta} \frac{\partial r}{\partial \phi}\right)^2}. \quad (2.12)$$

One can compare this equation with the two-dimensional (2.8). When the cloud into which the shock moves has a velocity, one has to take into account the component of this velocity perpendicular to the shock. This component u_n can be written in spherical coordinates. The angle $\tan \chi = D_\theta/D_\phi$ is by definition the angle between the projection of \vec{D} onto the surface and the ϕ unit vector.

$$u_n = u_r \cos \lambda + u_\theta \sin \lambda \sin \chi + u_\phi \sin \lambda \cos \chi.$$

Note that in two dimensions, χ is equal to 90 degrees and u_n becomes $u_r \cos \lambda + u_\theta \sin \lambda$ like in (2.10). Because $\sin \chi = D_\theta / \sqrt{D_\theta^2 + D_\phi^2}$, we can use the earlier equations to derive

$$\sin \chi = \frac{D_\theta/D_r}{\tan \lambda}.$$

and

$$\cos \chi = \frac{D_\phi/D_r}{\tan \lambda}.$$

Combining this with the equation for u_n , we get

$$u_n = u_r \cos \lambda - u_\theta \cos \lambda \frac{1}{r} \frac{\partial r}{\partial \theta} - u_\phi \cos \lambda \frac{1}{r \sin \theta} \frac{\partial r}{\partial \phi}. \quad (2.13)$$

From the theory of gas dynamics we know the jump conditions at the shock in equation (2.7). The speed of the shock wave front is then given by

$$D = u_n + \sqrt{(K)}.$$

By definition of λ , we have $D = \frac{\partial r}{\partial t} \cos \lambda$. This yields

$$\frac{\partial r}{\partial t} = u_r - u_\theta \frac{1}{r} \frac{\partial r}{\partial \theta} - u_\phi \frac{1}{r \sin \theta} \frac{\partial r}{\partial \phi} + \frac{\sqrt{K}}{\cos \lambda}.$$

The last term can be rewritten with help from the trigonometric formula $\frac{1}{\cos^2 \lambda} = 1 + \tan^2 \lambda$. So the general spherical formula for wind-driven point-explosions in an inhomogeneous atmosphere is

$$\frac{\partial r}{\partial t} = u_r - u_\theta \frac{1}{r} \frac{\partial r}{\partial \theta} - u_\phi \frac{1}{r \sin \theta} \frac{\partial r}{\partial \phi} + \sqrt{K \left[1 + \left(\frac{1}{r} \frac{\partial r}{\partial \theta} \right)^2 + \left(\frac{1}{r \sin \theta} \frac{\partial r}{\partial \phi} \right)^2 \right]}. \quad (2.14)$$

Chapter 3

Known work

Here we will reproduce the achievements made by [Kompaneets, 1960] and [Icke, 1988]. Both use the 2 dimensional equation (2.11).

$$\frac{\partial r}{\partial t} = u_r + \left\{ A \left[1 + \left(\frac{1}{r} \frac{\partial r}{\partial \theta} \right)^2 \right] \right\}^{\frac{1}{2}}.$$

3.1 Kompaneets (1960)

The Russian scientist Kompaneets derived back in 1960, [Kompaneets, 1960], the first analytic solution to equation (2.11). He considered the case where the external velocity is zero, hence $u = 0$ and he transformed this equation into Euclidean coordinates (r', z) , as can be seen in figure 3.1. We transform our (r, θ) coordinates in Kompaneets' (r', z) coordinates by

$$r = \sqrt{r'^2 + z^2}$$

and

$$z = r' \tan \theta.$$

Their derivatives become

$$\frac{\partial r}{\partial t} = \frac{\partial r}{\partial r'} \frac{\partial r'}{\partial t} = \frac{r'}{r} \frac{\partial r'}{\partial t}$$

and

$$\frac{\partial r}{\partial \theta} = \frac{\partial r}{\partial r'} \frac{\partial r'}{\partial z} \frac{\partial z}{\partial \theta} = \frac{r'}{r} r' (1 + \tan^2 \theta) \frac{\partial r'}{\partial z} = \frac{r'}{r} \frac{r^2}{r'} \frac{\partial r'}{\partial z} = r \frac{\partial r'}{\partial z}.$$

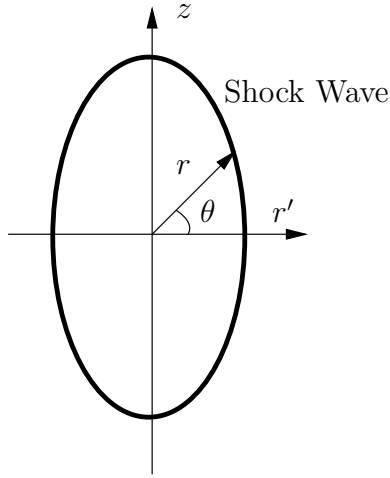

Figure 3.1: *The Euclidean coordinates (r', z) that Kompaneets used instead of the polar (r, θ) . These polar coordinates are defined in chapter 2 and can be seen in figure 2.1.*

Use these relations to rewrite equation (2.11).

$$\left(\frac{r'}{r} \frac{\partial r'}{\partial t}\right)^2 = A \left[1 + \left(\frac{\partial r'}{\partial z}\right)^2\right]. \quad (3.1)$$

Suppose that $A = \frac{\gamma+1}{2} \frac{P_1}{\rho_0} \frac{1}{\rho_*(z)}$ for some function $\rho_*(z)$. We substitute this into equation (3.1) and bring all the constants to the left side:

$$\left(\sqrt{\frac{r'^2}{r^2} \frac{2\rho_0}{(\gamma+1)P_1}} \frac{\partial r'}{\partial t}\right)^2 = \frac{1}{\rho_*(z)} \left[1 + \left(\frac{\partial r'}{\partial z}\right)^2\right].$$

Kompaneets assumed that the ratio of the energy density at the front to the mean energy density through the volume is constant. This leads to the conclusion that the factor in front could be put into an auxiliary variable named y by

$$y = \int_0^t dt \sqrt{\frac{r^2(\gamma+1)P_1}{2\rho_0 r'^2}}$$

so that the final equation becomes equal to equation (5) in [Kompaneets, 1960]:

$$\left(\frac{\partial r'}{\partial y}\right)^2 = e^{\frac{z}{z_0}} \left[\left(\frac{\partial r'}{\partial z}\right)^2 + 1\right] \quad (3.2)$$

where we have taken $\rho_*(z) = e^{-\frac{z}{z_0}}$ - which is similar to the earths atmosphere.

From now on we will write r instead of r' to avoid confusion. We use separation of variables, namely $r = H(y) + Z(z)$. This yields

$$\left(\frac{\partial H}{\partial y}\right)^2 = e^{z/z_0} \left[\left(\frac{\partial Z}{\partial z}\right)^2 + 1 \right]. \quad (3.3)$$

Both sides of this equation must be constant, since the left hand side only depends on y and the right side only depends on z . We call this constant ξ^2 for later convenience. Solving (3.3) gives us

$$\begin{aligned} \frac{\partial H}{\partial y} = \xi &\Rightarrow H = \xi y \\ e^{z/z_0} \left[\left(\frac{\partial Z}{\partial z}\right)^2 + 1 \right] = \xi^2 &\Rightarrow Z = \int_0^z dz' \sqrt{\xi^2 e^{-z'/z_0} - 1}. \end{aligned}$$

This solution for r also depends on a function $F(\xi)$. The solution for a specific ξ is called a *partial wave*:

$$r = \xi y + F(\xi) + \int_0^z dz' \sqrt{\xi^2 e^{-z'/z_0} - 1} \quad (3.4)$$

It turns out that the 'physical' solution - the relevant solution - is obtained by constructing an 'envelope' around the partial waves. In figure 3.2 one can see the geometric interpretation of the envelope and the mathematical background is stated in appendix A. According to this theory, we must solve $\frac{\partial r}{\partial \xi} = 0$.

First we look at the partial wave at $z = 0$. Then $r = \xi y + F(\xi)$. Our initial condition for small t (and thus for small y) is that the shock wave is also very small. That is, r tends to zero. Because y also tends to zero, we must have $F(\xi) = 0$ for all ξ . Since $F(\xi)$ doesn't depend on y or z either, it must remain zero. We start to derive the solution by differentiating with respect to ξ :

$$\frac{\partial r}{\partial \xi} = y + \int_0^z dz' \frac{\xi e^{-z'/z_0}}{\sqrt{\xi^2 e^{-z'/z_0} - 1}} = 0. \quad (3.5)$$

First, we eliminate ξ from equations (3.4) and (3.5) and solve for r :

$$y = - \int_0^z dz' \frac{\xi e^{-z'/z_0}}{\sqrt{\xi^2 e^{-z'/z_0} - 1}}.$$

We introduce $\omega = \xi^2 e^{-\frac{z}{z_0}} - 1$, so then $z' = -z_0 \ln(\frac{\omega+1}{\xi^2})$ and $dz' = -z_0 \frac{1}{\omega+1} d\omega$ and the integral becomes:

$$y = - \int_{\xi^2-1}^{\xi^2 e^{-\frac{z}{z_0}}-1} d\omega \left(-z_0 \frac{1}{\omega+1} \right) \frac{1}{\sqrt{\omega}} \frac{\omega+1}{\xi} = \int_{\xi^2-1}^{\xi^2 e^{-\frac{z}{z_0}}-1} d\omega \frac{z_0}{\xi} \frac{1}{\sqrt{\omega}}.$$

This gives us an integral we can compute and solve for ξ :

$$y = \frac{z_0}{\xi} (-2) [\sqrt{\omega}]_{\xi^2-1}^{\xi^2 e^{-\frac{z}{z_0}}-1} = -\frac{2z_0}{\xi} \left(\sqrt{\xi^2 e^{-\frac{z}{z_0}} - 1} - \sqrt{\xi^2 - 1} \right).$$

Call $x = \frac{y}{2z_0}$ and solve for ξ^2 :

$$\begin{aligned} \sqrt{\xi^2 e^{-\frac{z}{z_0}} - 1} - \sqrt{\xi^2 - 1} &= -\xi x \\ \xi^2 e^{-\frac{z}{z_0}} - 1 + \xi^2 - 1 - 2\sqrt{(\xi^2 e^{-\frac{z}{z_0}} - 1)(\xi^2 - 1)} &= \xi^2 x^2 \\ \xi^2 \left(1 - x^2 + e^{-\frac{z}{z_0}} \right) - 2 &= 2\sqrt{(\xi^2 e^{-\frac{z}{z_0}} - 1)(\xi^2 - 1)} \\ \xi^4 \left(1 - x^2 + e^{-\frac{z}{z_0}} \right)^2 + 4 - 4\xi^2 \left(1 - x^2 + e^{-\frac{z}{z_0}} \right) &= 4(\xi^2 e^{-\frac{z}{z_0}} - 1)(\xi^2 - 1) \\ \xi^4 \left(1 - x^2 + e^{-\frac{z}{z_0}} \right)^2 + 4 - 4\xi^2 + 4\xi^2 x^2 - 4e^{-\frac{z}{z_0}} &= 4\xi^4 e^{-\frac{z}{z_0}} - 4\xi^2 e^{-\frac{z}{z_0}} - 4\xi^2 + 4 \\ \xi^4 \left(1 - x^2 + e^{-\frac{z}{z_0}} \right)^2 + 4\xi^2 x^2 - 4\xi^4 e^{-\frac{z}{z_0}} &= 0 \\ \xi^2 \left(\xi^2 \left(1 - x^2 + e^{-\frac{z}{z_0}} \right)^2 + 4x^2 - 4\xi^2 e^{-\frac{z}{z_0}} \right) &= 0. \end{aligned}$$

The solution $\xi^2 = 0$ is not a relevant solution, because it causes the partial waves to be imaginary. So we should take a look at the other solution:

$$\begin{aligned} \xi^2 \left(1 - x^2 + e^{-\frac{z}{z_0}} \right)^2 + 4x^2 - 4\xi^2 e^{-\frac{z}{z_0}} &= 0 \\ \xi^2 \left(\left(1 - x^2 + e^{-\frac{z}{z_0}} \right)^2 - 4e^{-\frac{z}{z_0}} \right) &= -4x^2 \\ \xi^2 &= \frac{4x^2}{4e^{-\frac{z}{z_0}} - \left(1 - x^2 + e^{-\frac{z}{z_0}} \right)^2} \\ \xi^2 &= \frac{x^2}{e^{-\frac{z}{z_0}} - \frac{1}{4} \left(1 - x^2 + e^{-\frac{z}{z_0}} \right)^2}. \end{aligned}$$

After substituting this ξ^2 into the partial wave (3.4) we can determine

$$\int_0^z dz' \sqrt{\xi^2 e^{-\frac{z'}{z_0}} - 1}:$$

$$\begin{aligned} \int_0^z dz' \sqrt{\xi^2 e^{-\frac{z'}{z_0}} - 1} &= \int_0^z dz' \left[\frac{x^2 e^{-\frac{z'}{z_0}}}{e^{-\frac{z'}{z_0}} - \frac{1}{4} \left(1 - x^2 + e^{-\frac{z'}{z_0}}\right)^2} - 1 \right]^{\frac{1}{2}} \\ &= \int_0^z dz' \left[\frac{x^2}{1 - \frac{1}{4} e^{\frac{z'}{z_0}} \left(1 - x^2 + e^{-\frac{z'}{z_0}}\right)^2} - 1 \right]^{\frac{1}{2}} \\ &= \int_0^z dz' \left[\frac{x^2 - 1 + \frac{1}{4} e^{\frac{z'}{z_0}} \left(1 - x^2 + e^{-\frac{z'}{z_0}}\right)^2}{1 - \frac{1}{4} e^{\frac{z'}{z_0}} \left(1 - x^2 + e^{-\frac{z'}{z_0}}\right)^2} \right]^{\frac{1}{2}}. \end{aligned}$$

As $\frac{\partial \arccos(\eta)}{\partial z'} = -\frac{1}{\sqrt{1-\eta^2}} \frac{\partial \eta}{\partial z'}$ with $\eta = \frac{1}{2} e^{\frac{z'}{z_0}} \left(1 - x^2 + e^{-\frac{z'}{z_0}}\right)$, this turns out to be equal to

$$\int_0^z dz' \sqrt{\xi^2 e^{-\frac{z'}{z_0}} - 1} = 2z_0 \left[\arccos \left(\frac{1}{2} e^{\frac{z'}{z_0}} \left(1 - x^2 + e^{-\frac{z'}{z_0}}\right) \right) \right]_0^z. \quad (3.6)$$

The physical solution r becomes:

$$r = G(y) + 2z_0 \arccos \left(\frac{1}{2} e^{\frac{z}{2z_0}} \left(1 - x^2 + e^{-\frac{z}{z_0}}\right) \right) \quad (3.7)$$

where $x = \frac{y}{2z_0}$ and $G(y)$ is a function that only depends on y . We can use the boundary conditions to obtain $G(y)$. Initially, the shock wave must be spherical, so for small y r should be proportional to $\sqrt{a^2 - z^2}$. We know that $\arccos(\eta) \approx \sqrt{1-\eta^2}$ when $\eta \rightarrow 1$. When y is small, so is x , therefore setting $\frac{1}{2} x^2 e^{\frac{z}{2z_0}} = \delta$ with $\delta > 0$ but small in (3.7) yields:

$$r - G(y) = 2z_0 \arccos \left(\frac{1}{2} e^{\frac{z}{2z_0}} \left(1 + e^{-\frac{z}{z_0}}\right) - \delta \right)$$

Making a Taylor expansion of $\frac{1}{2} e^{\frac{z}{2z_0}} \left(1 + e^{-\frac{z}{z_0}}\right)$ gives us:

$$r - G(y) = 2z_0 \arccos \left(1 + \frac{z^2}{8} + O(z^4) - \delta \right).$$

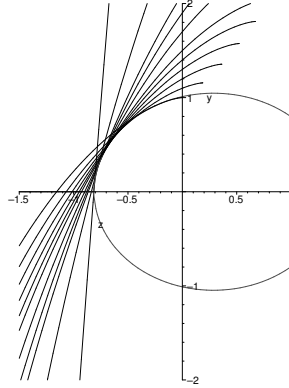

Figure 3.2: *The construction of the envelope for the Kompaneets case. We see the final solution as an ellipse with various partial waves surrounding it.*

We can approximate this with

$$r - G(y) = \frac{z_0}{\sqrt{2}} \sqrt{8\delta - z^2}$$

which is a spherical function! Hence $G(y)$ must be zero in order to make r spherical. To conclude, we have the final function for $r(z, t)$ which is equal to equation (9) of [Kompaneets, 1960]:

$$r = 2z_0 \arccos \left(\frac{1}{2} e^{\frac{z}{2z_0}} \left(1 - x^2 + e^{-\frac{z}{z_0}} \right) \right). \quad (3.8)$$

3.2 Icke (1988)

[Icke, 1988] suggested that $\rho = (r_0/r)^2 \rho_*(\theta)$ makes sense as a physical density distribution. With this density distribution A becomes $A = \frac{\gamma+1}{2} \frac{P_1}{\rho_*} \left(\frac{r}{r_0} \right)^2 = A_* \left(\frac{r}{r_0} \right)^2$. We substitute $x = \log\left(\frac{r}{r_0}\right)$ into (2.11), which means $r = r_0 e^x$ and $\frac{\partial r}{\partial x} = r_0 e^x$. This yields

$$r_0 \frac{\partial x}{\partial t} = u_r e^{-x} + \left\{ A_* \left[1 + \left(\frac{\partial x}{\partial \theta} \right)^2 \right] \right\}^{\frac{1}{2}}. \quad (3.9)$$

In section 2.2 of [Icke, 1988] it is argued that the contribution of the distribution to the external velocity field can be neglected due the exponential

decrease e^{-x} . This exponential factor e^{-x} causes the size of the cloud to change, not the shape. We are only interested in the shape, so it is safe to assume $u_r = 0$. With this assumption (3.9) becomes:

$$\frac{\partial x}{\partial \tau} = \left\{ A(\theta) \left[1 + \left(\frac{\partial x}{\partial \theta} \right)^2 \right] \right\}^{\frac{1}{2}}. \quad (3.10)$$

with $\tau = tr_0 \left(\frac{\gamma+1}{2} \frac{P_1}{\rho_*} \right)^{-\frac{1}{2}}$ and $A(\theta)$ a normalized dimensionless function of the latitude θ . Using separation of variables and integrating yields:

$$\begin{aligned} \frac{\partial x}{\partial \tau} = E &\implies x = E\tau + f(\theta, E) \\ \left\{ A(\theta) \left[1 + \left(\frac{\partial f(\theta, E)}{\partial \theta} \right)^2 \right] \right\}^{\frac{1}{2}} = E &\implies f(\theta, E) = \pm \int d\theta \sqrt{\frac{E^2}{A(\theta)} - 1} + f(E). \end{aligned}$$

Evaluation at $x = 0$ shows that the minus sign is the physical relevant one, so we drop the \pm and use the $-$. Note the difference with Kompaneets' separation of variables. He suggested $r = H(t) + Z(z)$, Icke suggested $x = E\tau + f(\theta, E)$ which effectively means $r = r_0 e^{E\tau} e^{f(\theta, E)}$. So x is:

$$x = E\tau - \int d\theta \sqrt{\frac{E^2}{A(\theta)} - 1} + f(E). \quad (3.11)$$

The complete integral - the part that we still have to solve - $T(E, \theta)$ is defined as

$$T(E, \theta) = \int d\theta \sqrt{\frac{E^2}{A(\theta)} - 1}. \quad (3.12)$$

As a boundary condition, we suppose that the shock wave starts at $\tau = 0$ as a sphere with radius $r = r_0$, hence $x(0) = 0$. As $f(E)$ is independent of time τ and latitude θ it must be the zero function. This gives us as function of the radius r :

$$r = r_0 e^x = r_0 e^{E\tau} e^{-\int d\theta \sqrt{\frac{E^2}{A(\theta)} - 1}}. \quad (3.13)$$

This function gives a set of solutions for every E . A solution for a constant E is called a *partial wave*. The physical interesting solution is the envelope constructed by solving $\partial T / \partial E = 0$. This is the envelope containing the partial waves. In most cases, this cannot be done analytically and must therefore be calculated numerically. Icke suggested the following form for the acceleration parameter A :

$$A(\theta) \equiv \delta + (1 - \delta) e^{-\frac{\theta^2}{\sigma^2}} \quad (3.14)$$

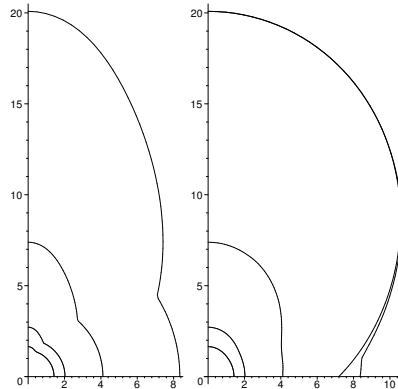

Figure 3.3: *Solution of the shock propagation for dimensionless times $t = 0.5, 1, 2$ and 3 . Left: $\sigma = 10^\circ$ and $\delta = 0.5$. Right: $\sigma = 40^\circ$ and $\delta = 0.5$. This figure is equal to figure 7 from [Icke, 1988].*

with $0 \leq \delta \leq 1$. In figure 3.4 one can see for $\tau = 0$ the different values for the complete integral T . At later times, the complete integral ought to be shifted an amount $E\tau$, as can be seen in the equation for x . In the right picture of 3.4 we have this 'shifted' complete integral for $\tau = 2$. We see that several partial waves construct one outer boundary, the envelope. This is the physical solution of the equation. Figure 3.3 shows the final solution of the propagation of the shock wave for two different cases.

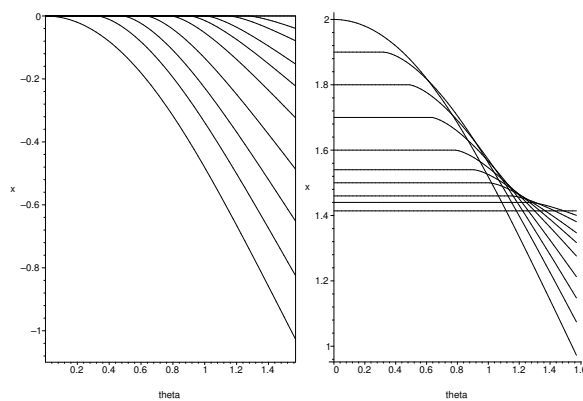

Figure 3.4: *The function x for $\sigma = 40^\circ$ and $\delta = 0.5$ and several E . Left: $t = 0$, Right: $t = 2$. These figures are equal to figure 4 and 5 resp. from [Icke, 1988].*

Chapter 4

Given A , what is r ?

In Chapter 2, we derived an equation that describes the propagation of the shock wave, given an initial density profile. The density "enters" the equation in the form of A , which is the reciprocal of the density. As [Icke, 1988] showed, we can neglect the external velocity of the gas, u . When we take this into account, the equation becomes

$$\frac{\partial r}{\partial t} = \sqrt{A \left[1 + \left(\frac{1}{r} \frac{\partial r}{\partial \theta} \right)^2 \right]}. \quad (4.1)$$

In this chapter, we will solve this equation for various typical $A = \frac{\gamma+1}{2} \frac{P_1}{\rho_0}$.

4.1 Constant A

As always, we will start with the simplest case. We consider equation (4.1) for constant A . We can square the equation to obtain

$$\left(\frac{\partial r}{\partial t} \right)^2 = A + A \left(\frac{1}{r} \frac{\partial r}{\partial \theta} \right)^2. \quad (4.2)$$

We can apply separation of variables with $r = H(t)f(\theta)$.

$$\left(\frac{dH}{dt} \right)^2 = \frac{A}{f^2} \left[1 + \left(\frac{df/d\theta}{f} \right)^2 \right] \equiv E^2$$

The left hand side only depends on t and the right hand side only on θ , so they must be equal to a constant. The ordinary differential equations for H

and f become

$$\begin{aligned}\frac{dH}{dt} &= E \\ \frac{df}{d\theta} &= f\sqrt{f^2E^2/A - 1}.\end{aligned}$$

The solution for the time-dependent part is simply $H(t) = Et + c_t$ (c_t is the integration constant). At the end of our computation, we will fit these integration constants with our initial values. The equation for the angle-dependent part is more difficult. We can integrate the equation in a standard way:

$$\int d\theta = \int df \frac{1}{f\sqrt{f^2E^2/A - 1}}$$

This is a standard integral. When we evaluate it, we'll put all the integration constants together in the constant ϕ .

$$\theta - \phi = -\arctan\left(\frac{1}{\sqrt{f^2E^2/A - 1}}\right)$$

By simple algebra, we can rewrite this to obtain f :

$$\begin{aligned}\frac{1}{\tan^2(\phi - \theta)} &= f^2E^2/A - 1 \\ \frac{A}{\sin^2(\phi - \theta)} &= f^2E^2. \\ f(\theta) &= \pm \frac{\sqrt{A}}{E|\sin(\theta - \phi)|}.\end{aligned}\tag{4.3}$$

We now have a set of solutions $r(t, \theta, \phi, E, c_t)$ that looks like

$$r = \pm \left[t + \frac{c_t}{E}\right] \frac{\sqrt{A}}{|\sin(\theta - \phi)|}.\tag{4.4}$$

Since there is no preferred direction for our physical system, we have to eliminate ϕ . We can do by constructing the envelope around this family of solutions. We can find an expression for ϕ by differentiating r with respect to ϕ and set this equal to zero. (Note: The mathematical background for this technique is written down in appendix A). We will only consider the region $0 \leq \theta - \phi \leq \pi$, since f is periodic with this period.

$$\begin{aligned}0 = \frac{\partial r}{\partial \phi} &= \pm A^{1/2} \left[t + \frac{c_t}{E}\right] \frac{\cos(\phi - \theta)}{\sin^2(\phi - \theta)} \\ 0 &= \cos(\phi - \theta) \\ \phi &= \theta \pm \frac{\pi}{2}.\end{aligned}$$

Inserting this solution for ϕ results is

$$r(t) = \pm \left[A^{1/2}t + \frac{A^{1/2}c_t}{E} \right]. \quad (4.5)$$

Now we want the solution for an *expanding* shock wave, hence we choose the plus. At time $t = 0$, we define $r = r_0$ so that $A^{1/2}c_t/E = r_0$. Our final solution is

$$r(t) = \sqrt{At} + r_0. \quad (4.6)$$

This is something we would physically expect: Constant density leads to constant motion of the shock wave.

4.2 A proportional to r^2

Most spherically symmetric distributions of mass have a $1/r^2$ density function. It is therefore logical to study a solution for (4.1) with $A = A_0^2 r^2$. In this case we can again use the separation of variables $r = H(t)f(\theta)$. The general equation (4.1) now becomes

$$\begin{aligned} A_0^{-2} f^2 \left(\frac{dH}{dt} \right)^2 &= f^2 H^2 + H^2 \left(\frac{df}{d\theta} \right)^2 \\ \left[\frac{dH/dt}{A_0 H} \right]^2 &= 1 + \left[\frac{df/d\theta}{f} \right]^2 = E^2. \end{aligned} \quad (4.7)$$

(Note that we have used the same technique as in the previous section). Both the time and the angle equations are simple first order linear equations. That gives us the following solution, with c the integration constant,

$$r(\theta, t, E) = e^{EA_0 t + \theta \sqrt{E^2 - 1} + c}. \quad (4.8)$$

At $t = 0$, we want the wave to be spherically symmetric. Hence $e^{\theta \sqrt{E^2 - 1}}$ cannot depend on θ , so E must be 1. As before, we define $r(t = 0) = r_0$ so that $e^c = r_0$. Our final solution becomes

$$r(\theta, t) = r_0 e^{A_0 t}. \quad (4.9)$$

4.3 Solutions for $A \propto r^2 A(\theta)$

In our last section, we solved the equation for $A \propto r^2 A(\theta)$. There we obtained a solution where r was an exponential. It turns out to be very

useful to make a substitution to the logarithm of r :

$$x = \log \frac{r}{r_0}. \quad (4.10)$$

Suppose $A = A(\theta)r^2$. Then equation (4.1) can be rewritten in a very beautiful form, using $\partial r/\partial\theta = r\partial x/\partial\theta$ and $\partial r/\partial t = r\partial x/\partial t$.

$$\left(\frac{\partial x}{\partial t}\right)^2 = A(\theta) \left[1 + \left(\frac{\partial x}{\partial\theta}\right)^2 \equiv E^2.\right] \quad (4.11)$$

We immediately see that the left hand side only depends on t and the right hand side only depends on θ . This suggests separation of variables similar to the one in the last section:

$$x(t, \theta, E) = Et \pm \int \sqrt{E^2/A(\theta) - 1} d\theta + g(E) \quad (4.12)$$

Here is E our extra variable, and $g(E)$ is the integration constant, that may depend on E . [Icke, 1988] had pointed out that we have to take the minus sign before the integral and $g = 0$. All these so-called partial waves

$$x(t, \theta, E) = Et - \int \sqrt{E^2/A(\theta) - 1} d\theta \quad (4.13)$$

are solutions to our equation (4.11). However, as is proved in appendix A, we can also construct the envelope around this family of partial waves. The envelope appears to be the physical solution. To obtain it, we must solve

$$0 = \frac{\partial x}{\partial E} = t + \int \frac{E/A(\theta)d\theta}{\sqrt{E^2/A(\theta) - 1}} \quad (4.14)$$

in order to eliminate E .

The remainder of this section will be devoted to constructing an envelope for various density profiles $A(\theta)$. We will start with the simplest forms, namely the linear and quadratic density. Finally we will make some remarks on possible density profiles from observations.

4.3.1 Linear density

With 'linear density' we mean that $\rho \propto \frac{\theta}{\sigma} + 1$. In other words, we define $A = 1/(\frac{\theta}{\sigma} + 1)$. Insert this A into equation (4.13):

$$x = Et - \int d\theta \sqrt{E^2 \left(\frac{\theta}{\sigma} + 1\right) - 1}. \quad (4.15)$$

It appears that the integrand can be imaginary when $\frac{\theta}{\sigma} < E^{-2} - 1$. This makes physically no sense, so therefore we will only integrate over the real part of the integrand.

In general, the indefinite integral of $\sqrt{ax+b}$ is equal to $\frac{2}{3a}(ax+b)^{3/2}$. As pointed out in the last subparagraph, it's value at the lower limit of integration must be zero. Hence

$$x = Et - \frac{2\sigma}{3E^2} \left[E^2 \left(\frac{\theta}{\sigma} + 1 \right) - 1 \right]^{3/2}. \quad (4.16)$$

The next step is to eliminate E , as formulated by (4.14). This yields

$$\frac{\partial x}{\partial E} = t - 2(\theta + \sigma) \left[\frac{\theta}{\sigma} + 1 - \frac{1}{E^2} \right]^{1/2} + \frac{4\sigma}{3} \left[\frac{\theta}{\sigma} + 1 - \frac{1}{E^2} \right]^{3/2} = 0. \quad (4.17)$$

We simplified this equation by substituting $\zeta = \frac{1}{E^2}$ and $\phi = \frac{\theta}{\sigma} + 1$. Our expression simplifies:

$$\frac{t}{\sigma} = 2\phi(\phi - \zeta)^{1/2} - \frac{4}{3}(\phi - \zeta)^{3/2}$$

This is a cubic expression that can be solved directly for ζ . When solved we obtain 3 solutions: 2 complex and 1 real. We use the real solution, which is:

$$\zeta = \phi - \left(\frac{\sqrt[3]{(81t + 3\sqrt{-24\phi^3\sigma^2 + 729t^2})\sigma^2}}{6\sigma} + \frac{\phi\sigma}{\sqrt[3]{(81t + 3\sqrt{-24\phi^3\sigma^2 + 729t^2})\sigma^2}} \right)^2$$

Substituting this back into (4.16) yields an expression that can be plotted. This plotting of the shock wave form $r = r_0 e^{x(\theta,t)}$ for some times t for the angle θ with $\sigma = r_0 = 1$ has been done in figure 4.1.

Our exact solution contains two cubic roots, so the question whether this solution is always real comes naturally to mind. And actually it is, because according to a consequence of the intermediate value theorem, a cubic expression with only real coefficients has either one real and two complex conjugate solutions, or three real solutions. This is determined by its discriminant. That discriminant is:

$$\Delta = 4\alpha_1^3\alpha_3 - \alpha_1^2\alpha_2^2 + 4\alpha_0\alpha_2^3 - 18\alpha_0\alpha_1\alpha_2\alpha_3 + 27\alpha_0^2\alpha_3^2$$

for

$$\alpha_3x^3 + \alpha_2x^2 + \alpha_1x + \alpha_0 = 0$$

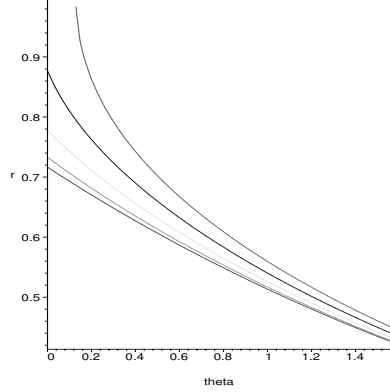

Figure 4.1: Shock wave for a linear density at dimensionless times $t = 0, 0.2, 0.4, 0.6$ and 0.8 . The angle θ is dimensionless with $\sigma = 1$.

When we plot this discriminant for $\sigma = 1$ and $\phi = \frac{\theta}{\sigma} + 1$ we obtain 4.2. As can be seen clearly, in the range $\theta = 0$ to 0.5 the value of the discriminant is always greater than zero. For $\theta > 0.5$ the discriminant increases even faster and is also bigger than zero. For $\Delta > 0$ there is one real solution and two complex conjugated ones. Our solution is the real one, the other two are each others complex conjugates.

If we evaluate the solution, it turns out that by choosing the right complex cubic root, the two complex parts cancel. We will demonstrate that in the case $t = 0$. That however does not lead to much understanding of the meaning of our solution. Hence let's look at the solution for ζ for $t = 0$ and $\sigma = 1$ with $\phi = \frac{\theta}{\sigma} + 1$ substituted back. Remember, σ is a constant and can therefore be chosen arbitrarily. The last equation yields in this case:

$$\begin{aligned} \zeta &= \theta + 1 - \left[\frac{3^{1/3} (-24(\theta + 1)^3)^{1/6}}{6} + \frac{(\theta + 1)3^{1/3}}{3(-24(\theta + 1)^3)^{1/6}} \right]^2 \\ \zeta &= \theta + 1 - \left[\frac{3^{2/3}(-24)^{1/3}(\theta + 1)}{36} + \frac{(\theta + 1)^2 3^{2/3}}{9(-24)^{1/3}(\theta + 1)} + 2 \frac{3(-24(\theta + 1)^3)^{1/6}(\theta + 1)}{18(-24(\theta + 1)^3)^{1/6}} \right] \\ \zeta &= \theta + 1 - (\theta + 1) \left[\frac{1}{12}(-8)^{1/3} + \frac{1}{3} \frac{1}{(-8)^{1/3}} + \frac{1}{3} \right] \\ \zeta &= (\theta + 1) \left[\frac{2}{3} - \frac{1}{12}(1 + i\sqrt{3}) - \frac{1}{3} \frac{1}{4}(1 - i\sqrt{3}) \right] \\ \zeta &= \frac{1}{2}(\theta + 1) \end{aligned}$$

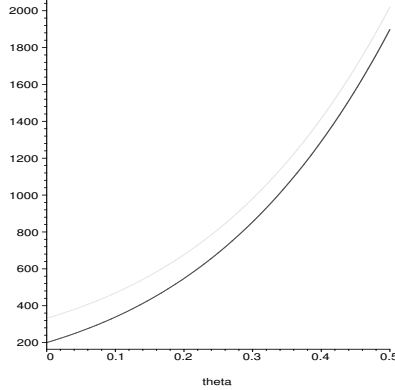

Figure 4.2: Value of the discriminant of the cubic polynomial for θ from 0 to 0.5.

Therefore E at $t = 0$ can be written as $\frac{1}{\sqrt{\frac{1}{2}(\theta+1)}}$.

For $t > 0$ we can make an asymptotic expansion, but because we have the exact solution, we do not need to.

4.3.2 Quadratic density

Our next problem is to derive a solution for a quadratic density profile. Similar to the linear case, we define the acceleration parameter as $A(\theta) = \frac{1}{(\frac{\theta^2}{\sigma^2} + 1)}$. Equation (4.13) becomes

$$x = Et - \int d\theta \sqrt{E^2 \left(\frac{\theta^2}{\sigma^2} + 1 \right) - 1}. \quad (4.18)$$

We have to solve $\frac{dx}{dE} = 0$ with E a function of solely t and θ .

Integral limits for x

Our first step is to write x explicitly in terms of E , t , θ and σ , that is without the integral sign. In order to eliminate the integral, we must define suitable integral limits. As mentioned earlier (see paragraph **3.1** and appendix **A**) we may consider E as a constant for each individual partial wave. Only for the final envelope, E will be a function of t and θ .

When we consider the integral part of (4.18), it turns out it is useful to make the substitution

$$\vartheta = \frac{E\theta}{\sigma}.$$

We obtain then $d\theta = \frac{\sigma}{E} d\vartheta$ and the integral transforms as follows

$$-\frac{\sigma}{E} \int d\vartheta \sqrt{\vartheta^2 - (1 - E^2)}.$$

In general this integral will run from ϑ_0 to ϑ . We can distinguish two cases, noting that $E^2 \geq 0$:

- $E^2 \geq 1$: here the integrand is always real
- $E^2 < 1$: here the integrand is imaginary for $\vartheta^2 < 1 - E^2$. This imaginary term of x will not affect the magnitude of the shock wave $r = e^x$. We can therefore ignore all imaginary contributions to x and start our integration at $\vartheta_0 = +\sqrt{1 - E^2}$. Note that we need the positive root, since the part where $-\sqrt{1 - E^2} < \vartheta < +\sqrt{1 - E^2}$ only contributes to the imaginary part of x .

So we can define ϑ_0 to be $+\sqrt{1 - E^2}$. A quick look at a table of standard integrals yields

$$\int dy \sqrt{y^2 - a} = \frac{y}{2} \sqrt{y^2 - a} - \frac{a}{2} \log(y + \sqrt{y^2 - a}). \quad (4.19)$$

Substituting $y = \vartheta$ and $a = 1 - E^2$ leaves us with the final integral:

$$\begin{aligned} x &= Et - \frac{\sigma}{2E} \left[\vartheta \sqrt{\vartheta^2 - (1 - E^2)} - \right. \\ &\quad \left. - (1 - E^2) \log(\vartheta + \sqrt{\vartheta^2 - (1 - E^2)}) \right]_{\vartheta_0 = \sqrt{1 - E^2}}^{\vartheta} \\ &= Et - \frac{\sigma}{2E} \left[\vartheta \sqrt{\vartheta^2 - (1 - E^2)} - (1 - E^2) \log(\vartheta + \sqrt{\vartheta^2 - (1 - E^2)}) + \right. \\ &\quad \left. + \frac{1 - E^2}{2} \log 1 - E^2 \right] \end{aligned} \quad (4.20)$$

Where we have used $\log \sqrt{1 - E^2} = \frac{1}{2} \log 1 - E^2$. Finally, we will express x exactly in terms of E , t , θ and σ .

$$\begin{aligned} x &= Et - \frac{\theta}{2} \sqrt{E^2 \left(\frac{\theta^2}{\sigma^2} + 1 \right) - 1} + \\ &\quad + \frac{\sigma(1 - E^2)}{2E} \log \left(\frac{E}{\sigma} \theta + \sqrt{E^2 \left(\frac{\theta^2}{\sigma^2} + 1 \right) - 1} \right) - \\ &\quad - \frac{\sigma(1 - E^2)}{4E} \log(1 - E^2) \end{aligned} \quad (4.21)$$

Differentiating x

Constructing the envelope means solving $\frac{dx}{dE} = 0$. So we must differentiate (4.21) with respect to E . Using the following derivatives, deriving this expression becomes easier:

$$\begin{aligned}\frac{d}{dE} \left(\frac{1}{E} (1 - E^2) \right) &= \frac{d}{dE} (E^{-1} - E) = - (E^{-2} + 1) \\ \frac{d}{dE} \sqrt{E^2 \left(\frac{\theta^2}{\sigma^2} + 1 \right) - 1} &= \frac{E \left(\frac{\theta^2}{\sigma^2} + 1 \right)}{\sqrt{E^2 \left(\frac{\theta^2}{\sigma^2} + 1 \right) - 1}}\end{aligned}$$

Now the derivative becomes:

$$\begin{aligned}\frac{dx}{dE} &= t - \frac{\theta \left(\frac{\theta^2}{\sigma^2} + 1 \right)}{2\sqrt{E^2 \left(\frac{\theta^2}{\sigma^2} + 1 \right) - 1}} + \\ &+ \frac{\sigma(1 - E^2)}{2E} \frac{\frac{\theta}{\sigma} + \frac{E \left(\frac{\theta^2}{\sigma^2} + 1 \right)}{\sqrt{E^2 \left(\frac{\theta^2}{\sigma^2} + 1 \right) - 1}}}{\frac{E\theta}{\sigma} + \sqrt{E^2 \left(\frac{\theta^2}{\sigma^2} + 1 \right) - 1}} - \\ &- \frac{\sigma}{2} \left(\frac{1}{E^2} + 1 \right) \log \left(\frac{E\theta}{\sigma} + \sqrt{E^2 \left(\frac{\theta^2}{\sigma^2} + 1 \right) - 1} \right) + \\ &+ \frac{\sigma}{4} \left(\frac{1}{E^2} + 1 \right) \log(1 - E^2) + \frac{\sigma}{2} \\ \frac{dx}{dE} &= t - \frac{\theta \left(\frac{\theta^2}{\sigma^2} + 1 \right)}{2\sqrt{E^2 \left(\frac{\theta^2}{\sigma^2} + 1 \right) - 1}} + \\ &+ \frac{\sigma}{2} \left(\frac{E^2 + 1}{E^2} \right) \log \frac{\sqrt{1 - E^2}}{\left(\frac{E\theta}{\sigma} + \sqrt{E^2 \left(\frac{\theta^2}{\sigma^2} + 1 \right) - 1} \right)} + \\ &+ \frac{\sigma}{2} \left(\frac{E^2 + 1}{E^2} \right) \frac{\frac{E\theta}{\sigma} + \frac{E^2 \left(\frac{\theta^2}{\sigma^2} + 1 \right)}{\sqrt{E^2 \left(\frac{\theta^2}{\sigma^2} + 1 \right) - 1}}}{\frac{E\theta}{\sigma} + \sqrt{E^2 \left(\frac{\theta^2}{\sigma^2} + 1 \right) - 1}} + \frac{\sigma}{2}\end{aligned}\tag{4.22}$$

The fourth term in (4.22) can be rewritten as:

$$+ \frac{\sigma}{2} \left(\frac{1 - E^2}{E^2} \right) \frac{\frac{E\theta}{\sigma} \sqrt{E^2 \left(\frac{\theta^2}{\sigma^2} + 1 \right) - 1} + E^2 \left(\frac{\theta^2}{\sigma^2} + 1 \right)}{\frac{E\theta}{\sigma} \sqrt{E^2 \left(\frac{\theta^2}{\sigma^2} + 1 \right) - 1} + E^2 \left(\frac{\theta^2}{\sigma^2} + 1 \right) - 1}\tag{4.23}$$

This solution seems quite messy, but we can simplify this expression if we introduce, similar to the linear case:

$$\zeta = \frac{1}{E^2} \quad (4.24)$$

$$\phi = \frac{\theta^2}{\sigma^2} + 1 \quad (4.25)$$

$$\text{so } \theta = \sigma \sqrt{\phi - 1}. \quad (4.26)$$

Hence we can rewrite (4.22) to obtain:

$$\begin{aligned} \frac{dx}{dE} &= t - \frac{\sigma}{2} \phi \sqrt{\frac{\phi-1}{\phi-\zeta}} + \frac{\sigma}{2} (\zeta + 1) \log \left(\frac{\sqrt{\zeta-1}}{\sqrt{\phi-1} + \sqrt{\phi-\zeta}} \right) + \\ &+ \frac{\sigma}{2} (\zeta - 1) \frac{\sqrt{\phi-1} \sqrt{\phi-\zeta} + \phi}{\sqrt{\phi-1} \sqrt{\phi-\zeta} + \phi - \zeta} + \frac{\sigma}{2}. \end{aligned} \quad (4.27)$$

To simplify this matter we will combine the last two terms

$$\begin{aligned} & \frac{\sigma}{2} \left[\frac{(\zeta-1)(\sqrt{\phi-1}\sqrt{\phi-\zeta}+\phi)+\sqrt{\phi-1}\sqrt{\phi-\zeta}+\phi-\zeta}{\sqrt{\phi-1}\sqrt{\phi-\zeta}+\phi-\zeta} \right] \\ &= \frac{\sigma}{2} \left[\frac{\zeta\sqrt{\phi-1}\sqrt{\phi-\zeta}+\phi\zeta-\zeta}{\sqrt{\phi-1}\sqrt{\phi-\zeta}+\phi-\zeta} \right] \\ &= \frac{\sigma}{2} \zeta \left[\frac{\sqrt{\phi-1}\sqrt{\phi-\zeta}+\phi-1}{\sqrt{\phi-1}\sqrt{\phi-\zeta}+\phi-\zeta} \right] \\ &= \frac{\sigma}{2} \zeta \frac{1+\sqrt{\frac{\phi-1}{\phi-\zeta}}}{1+\sqrt{\frac{\phi-\zeta}{\phi-1}}}. \end{aligned} \quad (4.28)$$

Finally, we can combine this result with the second term of (4.27) to obtain

$$\begin{aligned} & \frac{\sigma}{2} \left[\frac{\zeta \left(1 + \sqrt{\frac{\phi-1}{\phi-\zeta}} \right)}{1 + \sqrt{\frac{\phi-\zeta}{\phi-1}}} - \phi \sqrt{\frac{\phi-1}{\phi-\zeta}} \right] \\ &= \frac{\sigma}{2} \left[\frac{\zeta \left(1 + \sqrt{\frac{\phi-1}{\phi-\zeta}} \right) - \phi \sqrt{\frac{\phi-1}{\phi-\zeta}} \left(1 + \sqrt{\frac{\phi-\zeta}{\phi-1}} \right)}{1 + \sqrt{\frac{\phi-\zeta}{\phi-1}}} \right] \\ &= -\frac{\sigma}{2} (\phi - \zeta) \frac{1 + \sqrt{\frac{\phi-1}{\phi-\zeta}}}{1 + \sqrt{\frac{\phi-\zeta}{\phi-1}}} \\ &= -\frac{\sigma}{2} \sqrt{(\phi-1)(\phi-\zeta)}. \end{aligned} \quad (4.29)$$

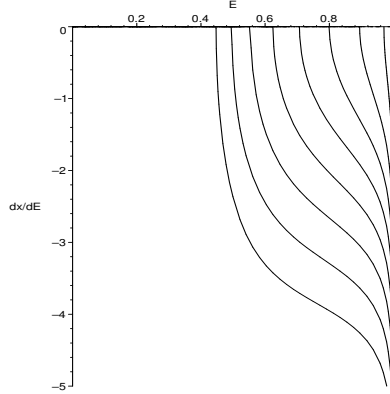

Figure 4.3: The derivative $\frac{\partial x}{\partial E}$ as a function of E at time $t = 0$. The various lines are, starting from the lowest, made for $\frac{\theta}{\sigma} = 2, 1.75, 1.5, 1.25, 1, 0.75, 0.5, 0.25$ and 0 .

Now rewriting (4.27) with help of the above simplifications yields

$$\frac{dx}{dE} = t - \frac{\sigma}{2} \sqrt{(\phi - 1)(\phi - \zeta)} + \frac{\sigma}{2} (\zeta + 1) \log \left(\frac{\sqrt{\zeta - 1}}{\sqrt{\phi - 1} + \sqrt{\phi - \zeta}} \right). \quad (4.30)$$

Figure 4.3 plots $\frac{dx}{dE}$ as a function of E for various values of θ at $t = 0$.

Properties of $x' = dx/dE$, solution for $t = 0$

Before solving equation (4.22) explicitly, we will take a closer look upon the properties of (4.30): limits, domain and range. It is convenient to use the physical notation $x' \equiv \frac{dx}{dE}$ from now on. At first sight, we immediately see asymptotic behavior at $E = 1$. If $E = 1$, $\zeta = 1$ and the logarithmic term in (4.30) goes to $\log(0) = -\infty$. Together with the lower boundary of ϑ_0 , we obtain a domain of x' in terms of E :

$$\frac{1}{\sqrt{\frac{\theta^2}{\sigma^2} + 1}} \leq E < 1 \quad (4.31)$$

We continue summarizing the properties of (4.30) and its limit points:

- x' is real whenever $\frac{1}{\sqrt{\frac{\theta^2}{\sigma^2} + 1}} \leq E < 1$ or equivalently $1 < \zeta \leq \phi$.
- In the region $\phi > \zeta$, the second and third term of (4.30) are negative, so $(x' - t) < 0$.

- Limit $\zeta = 1$: The logarithmic term will be

$$\sigma \log \frac{0}{2\sqrt{\phi-1}}.$$

So as long as $\phi \neq 1$, and thus $\phi \neq \zeta$, this term leads to $-\infty$. We may therefore conclude

$$\lim_{\zeta \rightarrow 1} (x' - t) = -\infty \text{ given } \phi \neq 1$$

- Limit $\zeta = \phi$: Now the logarithmic term will be (given that $\phi \neq 1$)

$$\frac{\sigma}{2}(\phi + 1) \log \frac{\sqrt{\phi-1}}{\sqrt{\phi-1}} = 0$$

and the second term will be:

$$-\frac{\sigma}{2} \sqrt{(\phi-1)(\phi-\zeta)} = 0.$$

So we find:

$$x'(\zeta = \phi) - t = 0 \tag{4.32}$$

- Limit $\zeta = \phi = 1$: We will approach this limit in 2 ways:

- First by taking $\phi = 1$ and then taking $\zeta = 1$: If we do that the second term vanishes when $\phi = 1$. Now the logarithmic term becomes:

$$\frac{\sigma}{4}(\zeta + 1) \log \frac{\zeta - 1}{1 - \zeta} = \frac{\sigma}{4}(\zeta + 1) \log(-1) = \frac{\sigma}{2}\pi i$$

So

$$\lim_{\zeta \rightarrow 1, \phi \rightarrow 1} x' - t = \frac{\sigma}{2}\pi i$$

- Secondly by taking $\zeta = \phi$ and then taking $\phi = 1$: If we first set $\zeta = \phi$ we get the result from (4.32). Setting $\phi = 1$ after that won't change this result.

We must conclude that this limit is undefined.

With just investigating the behavior of $x' = \frac{dx}{dE}$ we found that for $t = 0$ the solution of $x' = 0$ is, given the condition $E < 1$,

$$E = E_i \equiv \frac{1}{\sqrt{\frac{\theta^2}{\sigma^2} + 1}} \tag{4.33}$$

We have now formulated a value of E for the envelope at $t = 0$. Our next step is to calculate E at later times.

Later times $t > 0$, first order

We were not able to derive an exact solution due to the complexity of $\frac{dx}{dE}$. Therefore we will try to find approximations to the solution at $t > 0$. In this paragraph we will investigate a possible first order approximation. Note that due to the time evolution, x' gets shifted upwards linearly in t , that is $x'(t) = t + x'(t = 0)$. This time-shift causes the solution $E(t)$ to shift a bit too.

Then we can approximate $E(t)$ by taking the tangent line of x' at E_i . This tangent line is governed by

$$l(E_i) = t, l'(E) = \text{constant} = \left. \frac{dx'}{dE} \right|_{E=E_i}$$

and $E(t)$ can be found as the solution of the linear equation

$$l(E) = 0.$$

This procedure will only work if two conditions are met:

- $\frac{d^2x}{dE^2}(E_i)$ exists
- $\frac{dx}{dE}$ is a monotonically decreasing function between E_i and 1. Suppose it wouldn't be monotonically decreasing, then there would be more than one solution.

Let's start investigating these two conditions by calculating $\frac{d^2x}{dE^2}$ via (4.30). So we use:

$$\frac{dx'}{dE} = \frac{d\zeta}{dE} \frac{dx'}{d\zeta} = \frac{-2}{E^3} \frac{dx'}{d\zeta}$$

It turns out to be convenient to introduce new variables a and b

$$\begin{aligned} a &= \sqrt{\phi - \zeta} \\ b &= \sqrt{\phi - 1} \\ &\Rightarrow \\ \zeta &= b^2 - a^2 + 1 \\ \phi &= b^2 + 1. \end{aligned}$$

Such that:

$$\frac{dx'}{d\zeta} = \frac{dx'}{da} \frac{da}{d\zeta} = \frac{-1}{2a} \frac{dx'}{da}$$

Now x' becomes in terms of a and b :

$$\begin{aligned} x' &= t - \frac{\sigma}{2}ab + \frac{\sigma}{2} \log \left(\frac{\sqrt{b^2 + a^2}}{b + a} \right) (b^2 - a^2 + 2) \\ &= t - \frac{\sigma}{2}ab - \frac{\sigma}{4}(a^2 - (b^2 + 2)) [\log(b - a) - \log(b + a)] \end{aligned}$$

Finally, we can determine

$$\begin{aligned} \frac{dx'}{da} &= 0 - \frac{\sigma}{2}b - \frac{\sigma}{4}2a \left[\log \left(\frac{b - a}{b + a} \right) \right] - \frac{\sigma}{4}(a^2 - b^2 - 2) \left[-\frac{1}{b - a} - \frac{1}{b + a} \right] \\ &= -\frac{\sigma}{2}a \log \left(\frac{b - a}{b + a} \right) - \frac{\sigma}{2} \frac{(b^2 - a^2 + 2)b}{b^2 - a^2} - \frac{\sigma}{2} \frac{b(b^2 - a^2)}{b^2 - a^2} \\ &= -\frac{\sigma}{2}a \log \left(\frac{b - a}{b + a} \right) - \sigma b \frac{b^2 - a^2 + 1}{b^2 - a^2} \end{aligned}$$

Now just substituting ζ back in will suffice to find $\frac{d}{d\zeta} \frac{dx}{dE}$

$$\begin{aligned} \frac{dx'}{d\zeta} &= \frac{\sigma}{4} \log \left(\frac{b - a}{b + a} \right) + \frac{\sigma b}{2a} \left(\frac{b^2 - a^2 + 1}{b^2 - a^2} \right) \\ &= \frac{\sigma}{4} \log \left(\frac{\sqrt{\phi - 1} - \sqrt{\phi - \zeta}}{\sqrt{\phi - 1} + \sqrt{\phi - \zeta}} \right) + \frac{\sigma}{2} \sqrt{\frac{\phi - 1}{\phi - \zeta}} \frac{\zeta}{\zeta - 1} \end{aligned}$$

and to finally find $x'' \equiv \frac{d^2 x}{dE^2}$

$$\begin{aligned} x'' &= \frac{-\sigma}{2E^3} \log \left[\frac{\frac{\theta}{\sigma} - E^{-1} \sqrt{E^2 \left(\frac{\theta^2}{\sigma^2} + 1 \right) - 1}}{\frac{\theta}{\sigma} + E^{-1} \sqrt{E^2 \left(\frac{\theta^2}{\sigma^2} + 1 \right) - 1}} \right] + \\ &\quad + \frac{-\sigma}{E^3} \frac{E \frac{\theta}{\sigma}}{\sqrt{E^2 \left(\frac{\theta^2}{\sigma^2} + 1 \right) - 1}} \frac{1}{1 - E^2} \\ x'' &= -\frac{\sigma}{2E^3} \log \left[\frac{E \frac{\theta}{\sigma} - \sqrt{E^2 \left(\frac{\theta^2}{\sigma^2} + 1 \right) - 1}}{E \frac{\theta}{\sigma} + \sqrt{E^2 \left(\frac{\theta^2}{\sigma^2} + 1 \right) - 1}} \right] - \\ &\quad - \frac{\theta}{E^2(1 - E^2)} \frac{1}{\sqrt{E^2 \left(\frac{\theta^2}{\sigma^2} + 1 \right) - 1}} \end{aligned} \tag{4.34}$$

Now we can check the conditions stated above:

- $x''(E_i)$ clearly does not exist. The first term tends to zero when $E \rightarrow E_i$, whereas the second term goes to minus infinity. So $\lim_{E \rightarrow E_i} x'' = -\infty$.
- The first term is positive, even worse, it goes to plus infinity when $E \rightarrow 1$. The second term however is always negative and has asymptotes at $E = E_i$ and $E = 1$. So as long as the second term dominates, the condition $x'' < 0$ is met.

We know that $x' \rightarrow -\infty$ as $E \rightarrow 1$. So close to $E = 1$ we must find $x'' < 0$. Also $x'' < 0$ close to $E = E_i$, because there $x'' \rightarrow -\infty$. So if there is no E_0 such that $x''(E_0) = 0$, this second derivative must be negative everywhere.

To show this, reintroduce ζ and ϕ as introduced in (4.24) and (4.25) and write down $x'' = 0$

$$2\sqrt{\frac{\phi-1}{\phi-\zeta}} \frac{\zeta}{\zeta-1} = \log \left(\frac{\sqrt{\frac{\phi-1}{\phi-\zeta}} + 1}{\sqrt{\frac{\phi-1}{\phi-\zeta}} - 1} \right) \quad (4.35)$$

To simplify this expression, we use the auxiliary variables

$$\alpha = \sqrt{\frac{\phi-1}{\phi-\zeta}} \quad (4.36)$$

$$\beta = \frac{\zeta}{\zeta-1} \quad (4.37)$$

Now equation (4.35) becomes

$$2\alpha\beta = \log \frac{\alpha-1}{\alpha+1}$$

We know from (4.31), (4.24) and (4.25) that $\phi - \zeta > 0$ (since $\zeta = \phi$ is undefined for x'') and that $\zeta > 1$. Using these relations implies $\phi - 1 > \phi - \zeta > 0$ or $\alpha > 1$ and $\zeta > \zeta - 1 > 0$ or $\beta > 1$. Using these as lower boundaries for α and β we continue:

$$\begin{aligned} e^{2\alpha\beta} &= \frac{\alpha+1}{\alpha-1} \\ (\alpha-1)e^{2\alpha\beta} &= \alpha+1 \\ \alpha(e^{2\alpha\beta} - 1) &= 2. \end{aligned}$$

If we write $e^{2\alpha\beta}$ as its power series expansion, we get

$$\alpha(1 + 2\alpha\beta + O(\alpha^2\beta^2) - 1) = 2.$$

Since $\alpha > 1$ and $\beta > 1$, the left side of this expression is always bigger than 2. We can conclude that there is no solution for α or β and therefore for E_0 in the desired range. We may therefore conclude that $x''(E) < 0$ for $E_i \leq E < 1$.

We may conclude that a first order approximation is impossible.

Second order approximations

Nevertheless, from the fact that $x''(E) < 0$ we may conclude that for $t > 0$ there is only one solution for $\frac{dx}{dE} = 0$, defined by

$$E = E_i + O(t^2)$$

since any contribution linear in t is proven to be impossible.

Subsequently we may try looking for a second order solution, namely

$$E = E_i + \frac{t^2}{A^2} + O(t^3) \quad (4.38)$$

Now we know that in general $x' - t$ is a function that depends on E , θ and σ . Say $x' - t = f(E, \theta, \sigma)$. We may invert this and state:

$$E = f^{-1}(x' - t) = E_i + \frac{(x' - t)^2}{A^2} + O((x' - t)^3).$$

Which equals (4.38) if $x' = 0$ is solved. This yields:

$$x' - t \approx A\sqrt{E - E_i}.$$

Now we have an expression for the constant A :

$$A = \lim_{E \rightarrow E_i} \frac{x' - t}{\sqrt{E - E_i}} \quad (4.39)$$

There are two ways to calculate this A , namely via L'Hôpital's rule or via Taylor expansion.

Using L'Hôpital's rule

L'Hôpital's rule is stated as follows:

If $f(a) = g(a) = 0$ and we want to compute

$$L = \lim_{x \rightarrow a} \frac{f(x)}{g(x)}$$

then the limit L equals

$$L = \lim_{x \rightarrow a} \frac{f'(x)}{g'(x)}$$

Now differentiating (4.39) yields

$$A = \lim_{E \rightarrow E_i} 2x'' \sqrt{E - E_i}$$

Using (4.34) for x'' yields the following equation, as we already computed that the logarithmic term tends to zero in this limit.

$$A = \lim_{E \rightarrow E_i} -2\sqrt{E - E_i} \frac{\theta}{E^2(1 - E^2)} \frac{1}{\sqrt{E^2 E_i^{-2} - 1}}$$

When we now rewrite the fraction inside the square root we get:

$$\sqrt{\frac{E - E_i}{E^2 E_i^{-2} - 1}} = E_i \sqrt{\frac{E - E_i}{E^2 - E_i^2}} \rightarrow \frac{1}{2} \sqrt{2} E_i^{1/2}.$$

Finally improving the notation of

$$\frac{\theta}{1 - E_i^2} = \frac{\theta}{E_i^2(E_i^{-2} - 1)} = \frac{\sigma^2}{\theta E_i^2}$$

we obtain the following second order approximation for A

$$A = -\sqrt{2} \frac{\sigma^2}{\theta} E_i^{-7/2} \quad (4.40)$$

In figure 4.4 we plotted the approximation defined by (4.40) and (4.38) against the function x' itself. It seems a appropriate one.

Taylor expansion

Another method for determining solutions of the form (4.38) is to make a Taylor expansion of x' at $t = 0$. Therefore we insert our assumption for E into the exact expression for x' . Then we only consider the terms linear in t .

It is convenient to do this expansion in terms of ζ and ϕ . We assume

$$\zeta = \phi - at^2. \quad (4.41)$$

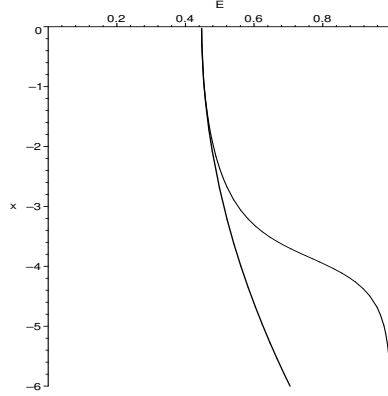

Figure 4.4: *Second-order approximation (bold line) compared to x' (thin line), with parameters $\theta = 2$, $\sigma = 1$ and $t = 0$.*

The relation between a in (4.41) and A^2 in (4.38) is given by the Taylor expansion

$$\begin{aligned} E &= E_i + t^2/A^2 \\ E^2 &= E_i^2 + 2E_it^2/A^2 + .. \\ \frac{1}{E^2} &= \frac{1}{E_i^2} - \frac{2}{A^2 E_i^3} t^2 + .. \\ \zeta &= \phi - at^2 \end{aligned}$$

so $a = \frac{2}{A^2 E_i^3}$ and $\frac{1}{A^2} = \frac{E_i^3}{2} a$.

Note that we obtain the following relations when we assume (4.41) and take a Taylor expansion:

$$\sqrt{\phi - \zeta} = a^{1/2} t \quad (4.42)$$

$$\sqrt{\zeta - 1} = \sqrt{\phi - 1} - \frac{a}{2\sqrt{\phi - 1}} t^2 + .. \quad (4.43)$$

$$\frac{1}{\sqrt{\phi - 1} + \sqrt{\phi - \zeta}} = \frac{1}{\sqrt{\phi - 1}} - \frac{a^{1/2}}{\phi - 1} t + .. \quad (4.44)$$

$$\frac{\sqrt{\zeta - 1}}{\sqrt{\phi - 1} + \sqrt{\phi - \zeta}} = 1 - \sqrt{\frac{a}{\phi - 1}} t + .. \quad (4.45)$$

In order to expand the logarithmic term in (4.30) we need

$$\log(1 + at) = at + .. \quad (4.46)$$

So now we can expand all terms from x' :

$$-\frac{\sigma}{2}\sqrt{(\phi-1)(\phi-\zeta)} = -\frac{\sigma}{2}\sqrt{\phi-1}a^{1/2}t + .. \quad (4.47)$$

$$\begin{aligned} \frac{\sigma}{2}(\zeta+1)\log\left(\frac{\sqrt{\zeta-1}}{\sqrt{\phi-1}+\sqrt{\phi-\zeta}}\right) &= \frac{\sigma}{2}(\zeta+1)\log\left(1-\sqrt{\frac{a}{\phi-1}}t+..\right) \\ &= -\frac{\sigma}{2}(\phi-at^2+1)\left(\sqrt{\frac{a}{\phi-1}}t+..\right) \\ &= -\frac{\sigma a^{1/2}(\phi+1)}{2\sqrt{\phi-1}}t + .. \end{aligned} \quad (4.48)$$

$$(4.49)$$

Hence we must solve $x' = 0$ for the terms linear in t :

$$0 = 1 - \frac{\sigma}{2}\sqrt{\phi-1}a^{1/2} - \frac{\sigma a^{1/2}(\phi+1)}{2\sqrt{\phi-1}}. \quad (4.50)$$

This is done in the following way.

$$\begin{aligned} 1 &= \frac{\sigma}{2}\frac{\sqrt{a}}{\sqrt{\phi-1}}(\phi-1+1+\phi) \\ 1 &= \sigma\frac{\sqrt{a}\phi}{\sqrt{\phi-1}} \\ \sqrt{a} &= \frac{1}{\sigma}\frac{\sqrt{\phi-1}}{\phi} \\ a &= \frac{1}{\sigma^2}\frac{\phi-1}{\phi^2} \end{aligned}$$

Now recall that $\phi = \frac{1}{E_i^2}$ so

$$\frac{\phi-1}{\phi^2} = \frac{E_i^4\theta^2}{\sigma^2}$$

and thus

$$\begin{aligned} \frac{1}{A^2} &= \frac{E_i^3}{2}a \\ &= \frac{\theta^2 E_i^7}{2\sigma^4} \end{aligned} \quad (4.51)$$

We can conclude that this method leads to exact the same solution as by using L'Hôpital's rule.

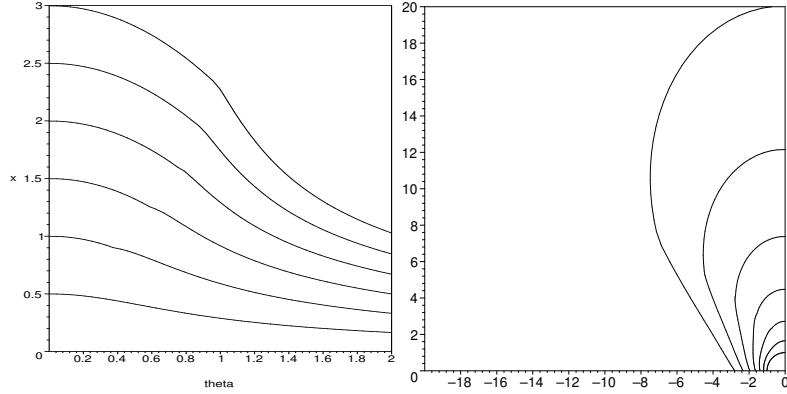

Figure 4.5: Shock wave fronts for the quadratic density profile, with $\sigma = 1$ and $t = 0, 0.5, 1, 1.5, 2, 2.5$ and 3 . Left: the function $x(\theta)$. Right: the polar projection of $r(\theta) = e^x$. The slight discontinuity is due to the approximation of E .

Conclusion

We wanted to solve $\frac{dx}{dE} = 0$ in order to find $E(\theta, \sigma, t)$. We made, in two different ways, a second order approximation from the $t = 0$ solution from (4.33) of the (4.38) form. The solution (4.40) and (4.51) equals:

$$E(\theta, \sigma, t) = E_i + \frac{\theta^2 E_i^7}{2\sigma^4} t^2 + O(t^3) \quad (4.52)$$

We have to put this into equation (4.20). However as we argued before E can never be more than 1. So in the calculations in figure 4.5 we used $\min(E, 1)$ instead of only equation (4.52).

4.3.3 Physical profiles

In chapter 5, we will derive shapes of the parameter A from observations. In figure 4.6, we have made a χ^2 -fit of the Hourglass nebula for two possible functions of $\rho = A^{-1}$:

$$\rho(\theta) = (1 - \mu)e^{-\left(\frac{\theta}{\sigma}\right)^2} + \mu \quad (4.53)$$

and

$$\rho(\theta) = 1 - \frac{2}{\pi}(1 - \delta) \arctan\left(\left(\frac{\theta}{\sigma}\right)^2\right). \quad (4.54)$$

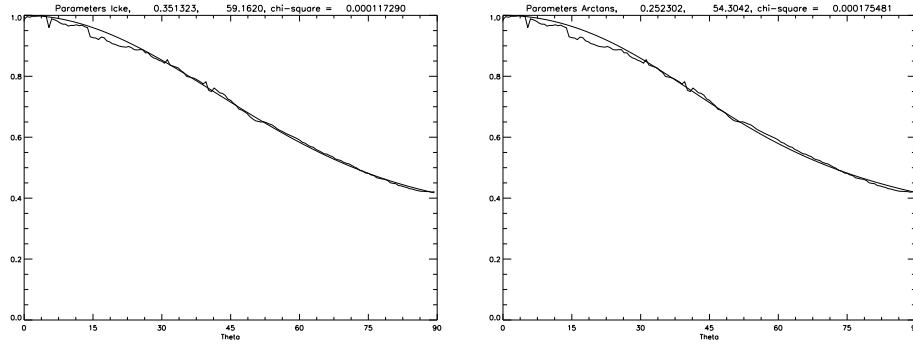

Figure 4.6: χ -square fits for the normalized density function of the Hourglass nebula with function (4.53) at the left and function (4.54) at the right. Left: $\mu = 0.3513$, $\sigma = 59.16^\circ$ and $\chi^2 = 0.00012$. Right: $\delta = 0.2523$, $\sigma = 54.30^\circ$ and $\chi^2 = 0.00018$.

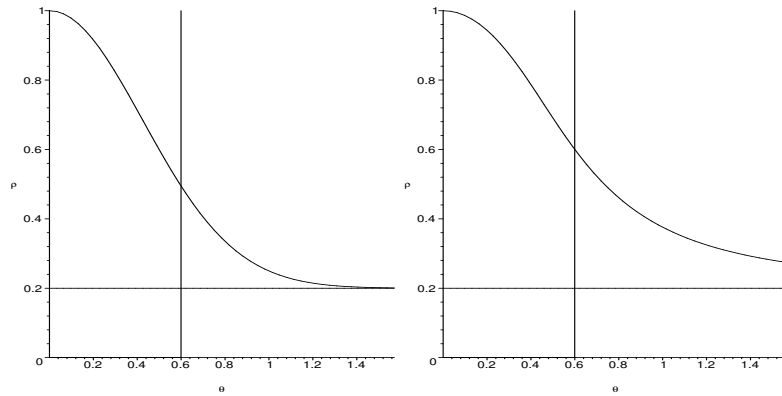

Figure 4.7: Left: A plot of (4.53). Right: A plot of (4.54). Both with $\mu = .2$ and $\sigma = .6$

We see in this figure that both equations are of great physical interest. They describe very accurately the quantitative shape of the density profile function. It would be a major achievement if we obtained analytical solutions for these functions. Unfortunately, we did not succeed (yet).

How did [Kompaneets, 1960] his computation work? He made use of a change of variables, but in his case, where $\rho(z') = e^{-\frac{z'}{z_0}}$, he uses $\omega = E^2 e^{-\frac{z'}{z_0}} - 1$, $z' = -z_0 \ln \frac{\omega+1}{E^2}$ and $dz' = -z_0 \frac{1}{\omega+1} d\omega$ and only in this special case $\frac{dz'}{d\omega} = -z_0 \frac{1}{\omega+1}$ cancels out against $\rho(\omega) = \frac{\omega+1}{E^2}$. Then all that remains to be calculated is $\int_0^z \frac{1}{\sqrt{\omega}}$.

So when you want to calculate the complete integral by direct calculation like Kompaneets did, this is to our present knowledge only possible when $\frac{d\theta}{d\omega} \rho(\omega) = P(\omega)$ with $\omega = E^2 \rho(\theta) - 1$ and $\frac{P(\omega)}{\sqrt{\omega}}$ an easy integrable function - like a polynomial or Kompaneets' function in [Kompaneets, 1960].

4.4 Toroidal Coordinates

There is a strong suggestion that there is initially a high-density torus around the star present. A star is created when a large cloud contracts and starts to rotate. Due to the rotation, the cloud becomes more and more disk-like. When finally the star starts emitting radiation, the gas near the star is blown away. What remains is a disk with the center taken out: a torus.

To cast this toroidal density into mathematics, we can use toroidal coordinates. The essence of this coordinate system can be seen in figure 4.8.

4.4.1 Transformation to Euclidean coordinates

We can express the toroidal coordinates in terms of (u, v) , as defined by [Moon & Spencer, 1961]. We still assume cylindrical symmetry of the planetary nebula, so that we can express our system in the xy -plane. The relation between Euclidean and Toroidal coordinates is then as follows:

$$x = \alpha \frac{\sinh v}{\cosh v - \cos u} \quad (4.55)$$

$$y = \alpha \frac{\sin u}{\cosh v - \cos u} \quad (4.56)$$

where α is the scale of the torus., hence the center of the torus is at $x = \alpha$.

We want to invert these transformations such that we get the toroidal coordinates in terms of Euclidean: $u = f(x, y)$ and $v = g(x, y)$. Therefore

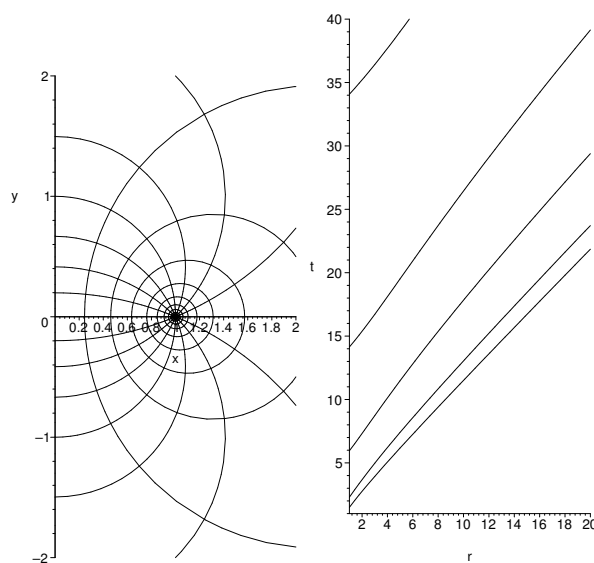

Figure 4.8: **Left:** Lines of a toroidal coordinate system with $\alpha = 1$. The concentric ellipses around $x = \alpha$ denote the lines of constant v , where the y -axis corresponds with $v = 0$ and $v \in [0, \infty)$. The lines perpendicular to these ellipses are the lines of constant u , where $u \in [0, 2\pi)$. The line from $x = \alpha$ to $x = 0$ is where $u = \pi$. **Right:** Plot of the solution (4.63) for $\alpha = 0.5, 1, 2.5, 5$ and 10 .

we commence with calculating $x^2 + y^2$:

$$x^2 + y^2 = \alpha^2 \left[\frac{\sinh^2 v + \sin^2 u}{(\cosh v - \cos u)^2} \right]. \quad (4.57)$$

It appears to simplify a lot when we add α^2 :

$$\begin{aligned} x^2 + y^2 + \alpha^2 &= \alpha^2 \left[\frac{\sinh^2 v + \sin^2 u}{(\cosh v - \cos u)^2} + 1 \right] \\ &= \alpha^2 \left[\frac{\sinh^2 v + \sin^2 u + (\cosh v - \cos u)^2}{(\cosh v - \cos u)^2} \right] \\ &= \alpha^2 \left[\frac{\sinh^2 v + \cosh^2 v + \sin^2 u + \cos^2 u - 2 \cos u \cosh v}{(\cosh v - \cos u)^2} \right] \\ &= \alpha^2 \left[\frac{\sinh^2 v + \cosh^2 v + 1 - 2 \cos u \cosh v}{(\cosh v - \cos u)^2} \right]. \end{aligned}$$

It hasn't simplified yet, but from the relation $\cosh^2 x - \sinh^2 x = 1$ we'll obtain $\sinh^2 v + \cosh^2 v + 1 = 2 \cosh^2 v$. The numerator simplifies considerable if we embed this relation into our expression.

$$\begin{aligned} x^2 + y^2 + \alpha^2 &= \alpha^2 \left[\frac{2 \cosh^2 v - 2 \cos u \cosh v}{(\cosh v - \cos u)^2} \right] \\ &= \alpha^2 \left[\frac{2(\cosh v - \cos u) \cosh v}{(\cosh v - \cos u)^2} \right] \\ &= 2\alpha^2 \frac{\cosh v}{\cosh v - \cos u}. \end{aligned} \quad (4.58)$$

Dividing (4.58) by $2\alpha x = 2\alpha^2 \frac{\sinh v}{\cosh v - \cos u}$ cancels out the u -dependence of the denominator.

$$\begin{aligned} \frac{x^2 + y^2 + \alpha^2}{2\alpha x} &= 2\alpha^2 \frac{\cosh v}{\cosh v - \cos u} \left(\frac{\cosh v - \cos u}{2\alpha^2 \sinh v} \right) \\ &= \frac{\cosh v}{\sinh v} \\ \frac{x^2 + y^2 + \alpha^2}{2\alpha x} &= \frac{1}{\tanh v} \end{aligned}$$

Thence we formulate our expression for v in terms of Euclidean coordinates.

$$v \equiv \operatorname{arctanh} \left(\frac{2\alpha x}{x^2 + y^2 + \alpha^2} \right). \quad (4.59)$$

Inspection of equation (4.57) indicates that we, if we want to cancel out the v -terms, should subtract α^2 :

$$\begin{aligned} x^2 + y^2 - \alpha^2 &= \alpha^2 \left[\frac{\sinh^2 v + \sin^2 u}{(\cosh v - \cos u)^2} - 1 \right] \\ &= \alpha^2 \left[\frac{\sinh^2 v - \cosh^2 v + \sin^2 u - \cos^2 u + 2 \cos u \cosh v}{(\cosh v - \cos u)^2} \right]. \end{aligned}$$

Analogous to our derivation for v , we can use $\sinh^2 v - \cosh^2 v = -1$ ergo $\sin^2 u - \cos^2 u - 1 = -2 \cos^2 u$. So we obtain

$$x^2 + y^2 - \alpha^2 = -2\alpha^2 \frac{\cos u}{\cosh v - \cos u}.$$

Again, we can divide this by $-2\alpha y = -2\alpha^2 \frac{\sin u}{\cosh v - \cos u}$, resulting in

$$\begin{aligned} \frac{\alpha^2 - x^2 + y^2}{2\alpha y} &= -2\alpha^2 \frac{\cos u}{\cosh v - \cos u} \left(\frac{\cosh v - \cos u}{-2\alpha^2 \sin u} \right) \\ &= \frac{\cos u}{\sin u} \\ &= \frac{1}{\tan u}. \end{aligned}$$

Consequently:

$$u \equiv \arctan \left(\frac{2\alpha y}{\alpha^2 - x^2 - y^2} \right). \quad (4.60)$$

4.4.2 Transformation to Polar coordinates

For polar coordinates, we use

$$\begin{aligned} x &= r \cos \theta \\ y &= r \sin \theta. \end{aligned}$$

From this, we directly get the relationship $r^2 = x^2 + y^2$. We can substitute this into equations (4.60) and (4.59), yielding:

$$u = \arctan \frac{2\alpha r \sin \theta}{\alpha^2 - r^2} \quad (4.61)$$

$$v = \operatorname{arctanh} \frac{2\alpha r \cos \theta}{r^2 + \alpha^2}. \quad (4.62)$$

Note that $\operatorname{arctanh} x = \frac{1}{2} \log \frac{1+x}{1-x}$.

4.4.3 A possible function for A

What we now try, is to find a function A that makes physically sense. Since $A \propto \rho$, it must have a minimum at $x = \alpha$ and may never be infinitely large. This is the same as saying that the density has a maximum at $x = \alpha$ and is never zero. Inspection of v strongly suggests a density profile of the form $\tanh v + 1$ so that

$$A = \frac{1}{\tanh v + 1} = \frac{r^2 + \alpha^2}{r^2 + 2\alpha r \cos \theta + \alpha^2}.$$

First, we start with investigating the general behavior of the corresponding $r(\theta, t)$ by using equation (2.11). We look at the equatorial plane $\theta = 0$ and suppose that $\frac{\partial r}{\partial \theta} \equiv r_\theta = 0$, so the PDE reduces to

$$\frac{\partial r}{\partial t} = \sqrt{A}.$$

and A reduces to

$$A = \frac{r^2 + \alpha^2}{(r + \alpha)^2}.$$

Solving the differential equation gives

$$\begin{aligned} \partial t &= \frac{\partial r}{\sqrt{A}} \\ \int \partial t &= \int \partial r \frac{r + \alpha}{\sqrt{r^2 + \alpha^2}} \\ t &= \alpha \log(r + \sqrt{r^2 + \alpha^2}) + \sqrt{r^2 + \alpha^2} + C. \end{aligned} \quad (4.63)$$

In figure 4.8 you can see the propagation of the shock wave for various α along the equatorial plane. It looks close to linear, which is rather odd! We would expect the shock wave to accelerate behind the torus, but it doesn't. We only see a light acceleration from $x = \alpha$ on.

Perhaps this absence of a significant acceleration is due to the fact that in this coordinate system we get a cusp at $\theta = 0$. Hence the approximation $r_\theta = 0$ is not good. Or the density function is still to smooth.

4.4.4 Numerical approximation

In order to get a more complete idea of the toroidal density, we will try to compute a solution. Assume that along the y -axis, which is at $\theta = \pi/2$, $A \propto r^2$. Our function for A will now be

$$A = \eta \frac{r^2}{\sigma \tanh v + 1} = \eta r^2 \frac{r^2 + \alpha^2}{r^2 + 2\alpha \sigma r \cos \theta + \alpha^2} \quad (4.64)$$

where η , σ and α are parameters of this model.

For the calculations, we cut up the θ -interval $(-\frac{\pi}{2}, \frac{\pi}{2})$ into n_θ pieces, that all have width $\Delta_\theta = \frac{\pi}{n_\theta}$. From the boundary condition $r(\theta, t = 0)$ on we can calculate the shock profile at the 'next' time, at $t = t_0 + \Delta_t$. The 'standard' way of computing this is:

$$r(\theta_i, t_{j+1}) = r(\theta_i, t_j) + \Delta_t \frac{dr(\theta_i, t_j)}{dt}. \quad (4.65)$$

The derivative dr/dt can be computing using the nearest neighbor approximation of (4.1):

$$\frac{dr(\theta_i, t_j)}{dt} = \left\{ A(\theta_i, t_j) \left[1 + \left(\frac{r(\theta_{i+1}, t_j) - r(\theta_{i-1}, t_j)}{2\Delta_\theta r(\theta_i, t_j)} \right)^2 \right] \right\}^{1/2}. \quad (4.66)$$

In figure 4.9 we have plotted the calculations for the shock for various α and σ . The beautiful result is, that the last image corresponds almost perfectly with the shock wave of the famous *Red Rectangle*, as can be seen in appendix D.1.

4.4.5 Red Rectangle

It is rather mystifying that the toroidal density leads to two sharp protrusions at about 40° from the y -axis in the nebula shape. One might raise the question whether these protrusions are an inaccuracy caused by our mathematical approximations. At first glance, one might suspect that the "real" shape should be Hourglass-like and the part we are showing might be caused by displaying the negative part of a square root for example. The expansion along the y -axis would then be *too slow*, if this assumption is correct.

However, we can compare our result in figure 4.9 (most-right) with the shock wave propagation for the spherical case, where the magnitude of A along the y -axis is the same: $A' = \eta r^2$. The result can be seen in figure 4.10 (left). As the magnitude is the same along the y -axis we expect the same propagation speed along the y -axis and thus the toroidal and spherical shock wave forms to overlap at this point. This happens, so our calculations along the y -axis shows that we must reject this 'Hourglass-hypothesis'. We must conclude that the protrusions are 'real', as long as our differential equation (4.1) holds.

We might wonder whether this behavior is general. In fact, it is. If we consider the original shock wave to have a "bump" along the x -axis, the

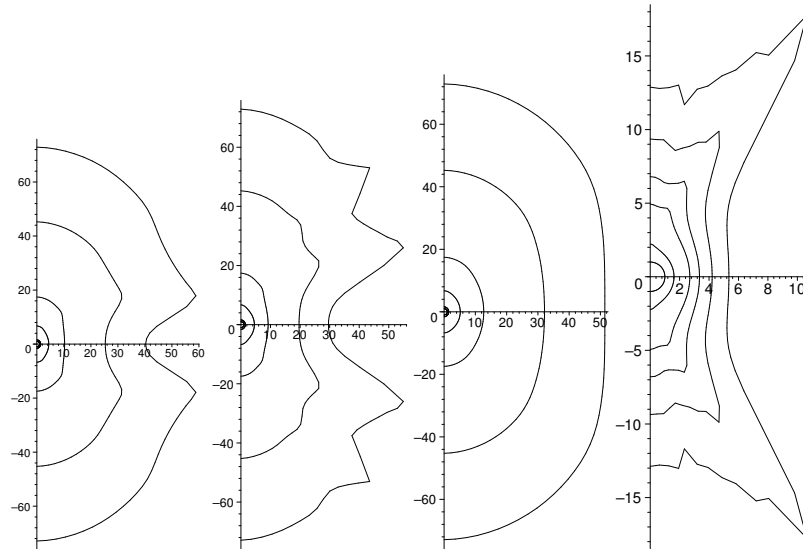

Figure 4.9: Numerical calculations of the shock wave for a toroidal density function. The left three shock waves are calculated with $\eta = 1$ at $t = 0, 0.5, 1, 1.5, 2, 3, 4$ and 4.5 . The intervals were $\Delta_t = 0.1$ and $n_\theta = 64$. The parameters, from left to right, were (1) $\alpha = 1, \sigma = 0.9$, (2) $\alpha = 5, \sigma = 0.9$, (3) $\alpha = 1, \sigma = 0.5$. The shock wave at the right has parameters $\eta = 3, \sigma = 2$ and $\alpha = 1$, and is calculated at $t = 0, 0.5, 1, 1.2, 1.4$ and 1.6 .

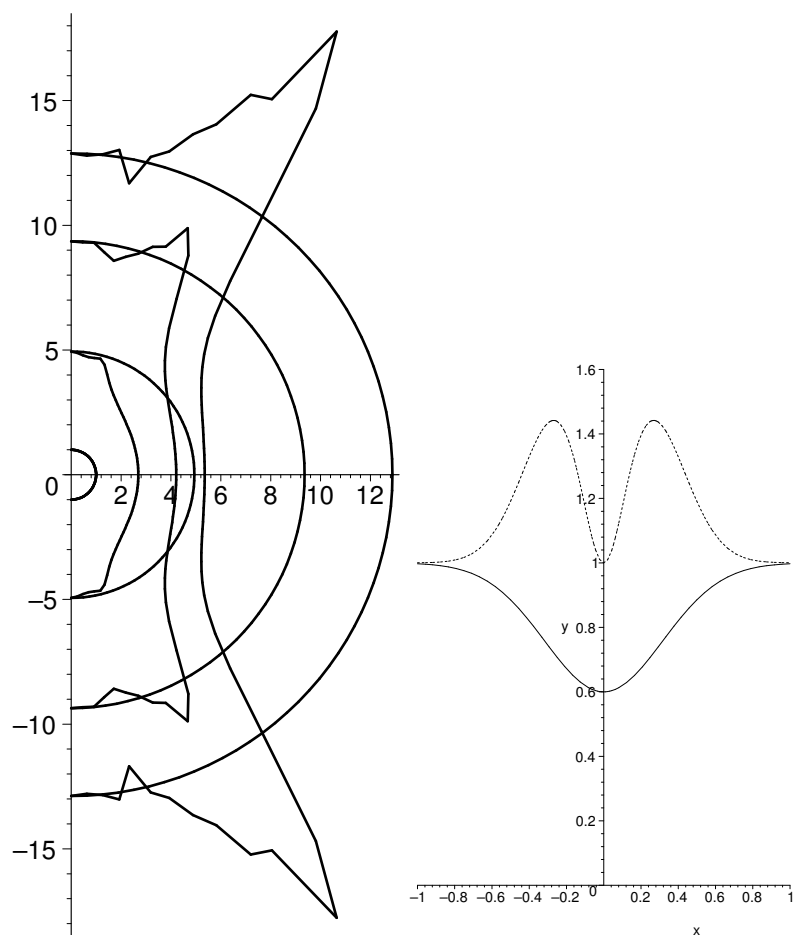

Figure 4.10: *Shock wave propagation. Left: spherical $A = \eta r^2$ and toroidal (equation 4.64) calculations compared. The parameters are $\alpha = 1$, $\sigma = 2$ and $\eta = 3$. The calculated times are $t = 0, 1, 1.4$ and 1.6 . Right: The solid line is a bumped test shock wave, the dashed line the corresponding expansion parameter.*

expansion coefficient from equation (4.1),

$$\sqrt{1 + \left(\frac{1}{r} \frac{\partial r}{\partial \theta}\right)^2},$$

becomes relatively large at the sides of this bump (where $\frac{\partial r}{\partial \theta}$ is the largest), as can be seen in the right side of figure 4.10. It then depends on the precise shape of this "bump" what the final result is: an Hourglass-like cusp in along the x -axis, or a Red Rectangle like shape with two protrusions.

4.4.6 Final comment on Toroidal coordinates

We see that the transformation into toroidal coordinates makes the equation mathematically very difficult. It is questionable whether we can solve the equation analytically. However, numerical models reveal very interesting properties of the toroidal density profile. The Red Rectangle can be reproduced in a toroidal model. This coordinate system should therefore be investigated further.

4.5 K independent of r in 3 dimensions

In the two-dimensional case, one can apply separation of variables successfully if K is independent of r . If one takes $r(\theta, t) = H(t)F(\theta)$, one gets:

$$\left(\frac{dH}{dt}\right)^2 = \frac{K}{F^2} \left[1 + \left(\frac{dF}{d\theta}\right)^2\right] \equiv E^2.$$

One can use this technique also in the 3-dimensional case with (2.14). Here we also use $u_r = u_\theta = u_\phi = 0$ and K a prediscrbed function of θ and ϕ . Then the separation of the time-variable leads to

$$E^2 F^4 = K \left[F^2 + F_\theta^2 + F_\phi^2 / \sin^2 \theta \right].$$

where E^2 is the integration constant. (We have $H(t) = Et + c_t$.) Then we can write $F = \Theta(\theta)\Phi(\phi)$ and we get

$$\frac{E^2 \Theta^2 \Phi^2 \sin^2 \theta}{K(\theta, \phi)} - \sin^2 \theta - \left(\frac{d\Theta}{d\theta} \sin \theta\right)^2 = \left(\frac{d\Phi}{d\phi}\right)^2.$$

Separation of variables can now only be obtained when $K(\theta, \phi) = A(\theta)\Phi^2(\phi)$. When we assume this relationship, the left hand side of the equation only depends on θ . The right hand side becomes the equation

$$\frac{d\Phi}{d\phi} = \xi\Phi.$$

This leads to the conclusion that $\Phi = c_\phi e^{\xi\phi}$. The differential equation for Θ becomes:

$$\begin{aligned} \frac{E^2\Theta^4}{A(\theta)} - \left(\frac{\xi^2}{\sin^2\theta} + 1\right)\Theta^2 &= \left(\frac{d\Theta}{d\theta}\right)^2. \\ \frac{d\Theta}{d\theta} &= \Theta\sqrt{\frac{E^2\Theta^2}{A(\theta)} - \left(\frac{\xi^2}{\sin^2\theta} + 1\right)}. \end{aligned}$$

Suppose now, similar to the ϕ -case, that $A(\theta) = \Theta^2$. Then we get the solution for Θ , that is:

$$\Theta = c_\theta e^{\int d\theta \sqrt{E^2 - 1 - \frac{\xi^2}{\sin^2\theta}}}. \quad (4.67)$$

This integral in the exponential can be solved analytically. The first step towards the solution of this integral are the substitution $x = \sin\theta$ (so $d\theta = \pm \frac{1}{\sqrt{1-x^2}}dx$, but as θ runs from 0 to π we may just use the positive part) and $B = \frac{E^2-1}{\xi^2}$, which leads to the following:

$$\begin{aligned} I &= \int d\theta \sqrt{E^2 - 1 - \frac{\xi^2}{\sin^2\theta}} \\ &= \xi \int d\theta \sqrt{\frac{E^2 - 1}{\xi^2} - \frac{1}{\sin^2\theta}} \\ &= \xi \int \frac{dx}{x} \sqrt{\frac{Bx^2 - 1}{1 - x^2}} \\ &= c_1 + \text{Im} \frac{\xi}{4B} \left[\sqrt{-B}(B+1) \arctan \left(\frac{(Bx^2 - 1) - B(1 - x^2)}{2\sqrt{B}\sqrt{(Bx^2 - 1)(1 - x^2)}} \right) \right. \\ &\quad \left. - 2\sqrt{-B^2} \arctan \left(\frac{(Bx^2 - 1) - (1 - x^2)}{2\sqrt{(Bx^2 - 1)(1 - x^2)}} \right) \right. \\ &\quad \left. + (B^{3/2} - B^{1/2}) \log \left(2\sqrt{(Bx^2 - 1)(1 - x^2)} - \frac{(Bx^2 - 1) - A(1 - x^2)}{\sqrt{-B}} \right) \right]. \end{aligned}$$

Because we only have to use the imaginary part, we can transform the logarithmic term into an arctan term by using the rule $Im(\log(x - iy)) = -\arctan(y/x)$:

$$I = c_1 + \frac{\xi}{2} \left[\sqrt{B} \arctan \left(\frac{(Bx^2 - 1) - B(1 - x^2)}{2\sqrt{B}\sqrt{(Bx^2 - 1)(1 - x^2)}} \right) - \arctan \left(\frac{(Bx^2 - 1) - (1 - x^2)}{2\sqrt{(Bx^2 - 1)(1 - x^2)}} \right) \right].$$

Now we substitute $x = \sin \theta$ back in the formula. Recall that $1 - x^2 = \cos^2 \theta$. We get:

$$I = c_1 + \frac{\xi}{2} \left[\sqrt{B} \arctan \left(\frac{B(\sin^2 \theta - \cos^2 \theta) - 1}{2\sqrt{B} \cos \theta \sqrt{(B \sin^2 \theta - 1)}} \right) - \arctan \left(\frac{B \sin^2 \theta - \cos^2 \theta - 1}{2 \cos \theta \sqrt{(B \sin^2 \theta - 1)}} \right) \right]. \quad (4.68)$$

Combining equations (4.68) and (4.67) with the relationship $r(t, \phi, \theta) = H(t)\Theta(\theta)\Phi(\phi)$ we have the partial wave as a function of ξ and E where $B = \frac{E^2 - 1}{\xi^2}$:

$$r = c_\phi (Et + c_t) e^{\xi\phi + c_1 + \frac{\xi}{2} \left[\sqrt{B} \arctan \left(\frac{B(\sin^2 \theta - \cos^2 \theta) - 1}{2\sqrt{B} \cos \theta \sqrt{(B \sin^2 \theta - 1)}} \right) - \arctan \left(\frac{B \sin^2 \theta - \cos^2 \theta - 1}{2 \cos \theta \sqrt{(B \sin^2 \theta - 1)}} \right) \right]}. \quad (4.69)$$

In order to construct the physical solution, one should make again an envelope for these partial waves. The system of equations

$$\begin{cases} \frac{\partial r}{\partial E} = 0 \\ \frac{\partial r}{\partial \xi} = 0 \end{cases} \quad (4.70)$$

should be solved for ξ and E . This might be a topic for further research.

4.6 What if $r \rightarrow \infty$?

The limiting behavior of a differential equation is interesting. The case for $r \rightarrow \infty$ can show more about the general shape of the shock wave at large time-scales. One might think, for example, that the shock wave eventually always becomes spherical. Let's examine this hypothesis.

The statement 'for large r the shock wave becomes spherical' can be stated mathematically in the form $r_\theta \rightarrow 0$ as $r \rightarrow \infty$. From equation (2.11) we get in this case $r_t \rightarrow \sqrt{A}$. We just took $r_\theta = 0$. This also implies $A_\theta = 0$, because $r_\theta = \frac{d}{d\theta} \int \sqrt{A} dt = \int \frac{d}{d\theta} \sqrt{A} dt = 0$. So we have the following result:

Proposition 4.6.1 (Spherical shock waves) *For large r , the shock wave becomes spherically symmetric if and only if the acceleration parameter A is spherically symmetric (does not depend on θ).*

We must note however that for large distances and time-scales, equation (2.11) no longer holds. The assumption that $p_1 \gg p_0$ only holds in the beginning. After a long time, the pressure behind the shock decreases and approaches the pressure in front of the shock. However, we shall restrict ourselves here to equation (2.11). Though it is physically not entirely correct, it still can tell us more about the shape of the shock wave.

We can investigate the case when $A = A(\theta)r^2/r_0^2$. This leads, according to [Icke, 1988], to equation (3.12), which are partial waves described by

$$r = r_0 e^{Et - \int_0^\theta \sqrt{E^2/A(\theta') - 1} d\theta'}. \quad (4.71)$$

For $\theta = 0$ we clearly get $r = r_0 e^t$. But what if $\theta = \frac{\pi}{2}$? Assume, without loss of generality, that $A(0) = 1$, $A(\theta = \frac{\pi}{2}) = \delta < 1$ and $A(\theta) \geq \delta$ at all times. Then the integral $\int_0^\theta \sqrt{E^2/A(\theta') - 1} d\theta'$ is always less than or equal to $\frac{\pi}{2} \sqrt{E^2/\delta - 1}$. So $r(\frac{\pi}{2})$ is always greater than or equal to:

$$r\left(\frac{\pi}{2}\right) \geq r_0 e^{Et - \frac{\pi}{2} \sqrt{E^2/\delta - 1}}.$$

Let's investigate the extreme case where an equality holds. By using the technique of envelopes, we get the solution $E = \frac{\delta t}{\sqrt{t^2 \delta - \frac{\pi^2}{4}}}$. Substituting this

into $r(\frac{\pi}{2})$ gives us

$$r\left(\frac{\pi}{2}\right) = r_0 e^{\sqrt{t^2 \delta - \frac{\pi^2}{4}}}. \quad (4.72)$$

We clearly see that if $r \rightarrow \infty$ then $r(\frac{\pi}{2})$ becomes of the form $r_0 e^{\sqrt{\delta} t}$. So we see that the axial ratio $H = \frac{r(0)}{r(\frac{\pi}{2})}$ becomes

$$H(t) = e^{t(1-\sqrt{\delta})}. \quad (4.73)$$

So we can conclude the following.

Proposition 4.6.2 (Large shock waves) *Assume $A = A(\theta)r^2/r_0^2$ and $A(0) = 1$ and $A(\theta) = \delta$. Then the ratio between the shock wave in the equatorial plane and in the polar plane is at most*

$$H(t) = e^{t(1-\sqrt{\delta})}.$$

So the shock wave becomes more and more asymmetric as the shock wave expands.

Chapter 5

Given r , what was ρ ?

In this section we try to reverse equation (2.11) such that we can calculate A or ρ for a given shock wave profile. First the theory is discussed, and then we will make numerical models for the shock wave of several planetary nebula. Finally, we will discuss the initial density profile for some shock wave functions.

5.1 Theory: The other way around

We make use of equation (2.11) with no external velocity, so $u_r = 0$. Inverting this equation gives

$$A(\theta, r) = \frac{(\partial r / \partial t)^2}{1 + \left(\frac{1}{r} \frac{\partial r}{\partial \theta}\right)^2}. \quad (5.1)$$

Suppose we can use separation of variables and write $r = H(t)f(\theta)$, where r is the radius of the shock wave at time t and angle θ . Then we have:

$$\begin{aligned} f \frac{dH}{dt} &= \left\{ A \left[1 + \left(\frac{1}{f} \frac{df}{d\theta} \right)^2 \right] \right\}^{\frac{1}{2}} \\ f \frac{dH}{dt} &= A^{\frac{1}{2}} \left[1 + \left(\frac{df}{f d\theta} \right)^2 \right]^{\frac{1}{2}} \\ A &= \frac{f^2 \frac{dH}{dt}^2}{1 + \left(\frac{df}{f d\theta} \right)^2} \end{aligned}$$

$$\begin{aligned}
A &= f^4 \left(\frac{dH}{dt} \right)^2 \left(f^2 + \left(\frac{df}{d\theta} \right)^2 \right)^{-1} \\
A &= \frac{r^4}{H^2} \left(\frac{dH}{dt} \right)^2 \left(\frac{r^2}{H^2} + \left(\frac{df}{d\theta} \right)^2 \right)^{-1} \\
\frac{1}{2}(\gamma + 1) \frac{P}{\rho} &= r^4 \left(\frac{dH}{dt} \right)^2 \left(r^2 + H^2 \left(\frac{df}{d\theta} \right)^2 \right)^{-1}.
\end{aligned}$$

We see that if $H(t)$ and $\frac{dH}{dt}(t)$ have also the dimension length as r has, and P is a constant, then $\rho \propto r^{-2}$ which is something we would expect.

Using the assumptions that $A\rho \propto 1$, $\frac{\partial r}{\partial t} \propto r$ and $\rho \propto \rho^*(\theta)/r^2$ we get from equation (5.1) a formula for $\rho^*(\theta)$:

$$\rho^*(\theta) = C \left(1 + \left(\frac{1}{r} \frac{\partial r}{\partial \theta} \right)^2 \right). \quad (5.2)$$

5.2 Test functions

We have determined $\rho(\theta)$ - or the angular density distributions - for a few when the characteristic shock shapes $r(\theta)$. The density distribution $\rho(\theta)$ for six shock waves can be seen in figures 5.1 to 5.2. It turns out that the initial density function develops a clover-like shape. It is also strange that the highest density is not where the shock wave has travelled the shortest distance.

This is something we don't understand physically. Note however that the 'bumps' can also be due to deficiencies in our assumptions for equation (5.2).

5.3 Numerical models

We used the IDL program to analyse observations. These observations are JPEG pictures from planetary nebula from the internet. The numerical code consists of three different parts¹:

1. Information. This part reads the data of the observed PN, and the user can define the center of the PN here. The information on the size of the image and the center is stored in a special .info file.

2. Analyse shock front. Now the program cancels out all the noise and other stars from the image. Then it 'looks out' from the center in every

¹For the complete program code look in appendix C.

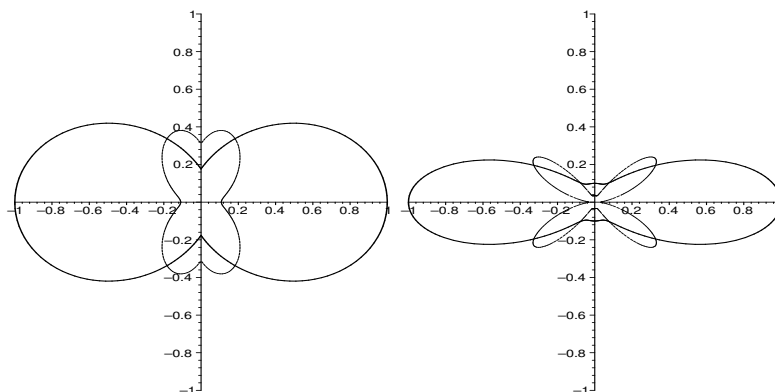

Figure 5.1: The thick line is $r(\theta) = (1 - \mu)e^{-\frac{\theta^2}{\sigma^2}} + \mu$ and the thin line is the normalized density function. Left: $\mu = 0.1$ and $\sigma = 1$. Right: $\mu = 0.1$ and $\sigma = 0.5$.

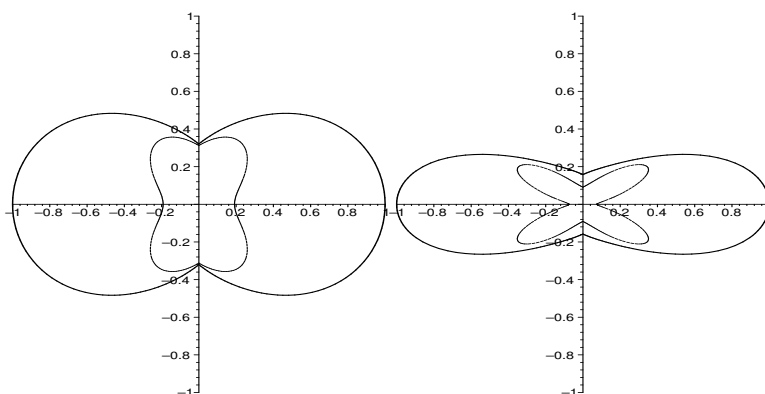

Figure 5.2: Same as in figure 5.1 but with $r(\theta) = 1 - \frac{2}{\pi}(1 - \delta) \arctan \frac{\theta^2}{\sigma^2}$. Left: $\delta = 0.1$ and $\sigma = 1$. Right: $\delta = 0.1$ and $\sigma = 0.5$.

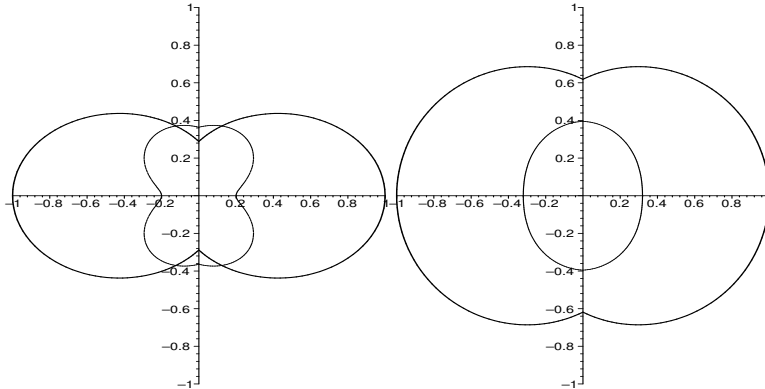

Figure 5.3: Same as in figure 5.1 but with $r(\theta) = \frac{1}{\frac{\theta^2}{\sigma^2} + 1}$. Left: $\sigma = 1$. Right: $\sigma = 2$.

angle and calculates the distance to the shock wave. In the first run, the shock wave is defined to start at the most outer place where the intensity becomes significant. In the second run we take the median for every 10 subsequent angles to get a more smooth result. The returned array $r(\theta)$ describes the radial distance of the shock wave for 360 degrees.

3. Calculate A. Now we have to calculate $\rho(\theta)$. Therefore we first calculate the derivative of $r(\theta)$ using the eight-points difference method. After that, we use the point symmetry of the PN to 'slide' the first and second half over each other. Most nebula are very point symmetric, so instead of calculating the density profile for 360^{deg}, we can calculate the average density profile over 180^{deg}. Finally we use equation 5.2 to calculate the density profile.

We use the observations of eleven planetary nebulae. The results for all these nebulae can be seen in Appendix D. From these pictures, we can clearly distinguish different types of nebulae.

Ellipsoidal. The Helix nebula, IC 3568 and NGC 6826 have a clear ellipsoidal density profile.

Disk. The Hourglass nebula, M27, M2-9, NGC 5307, NGC 6543a, NGC 7009 and Hubble 5 all show a typical point-symmetric density profile that consists of a disk along the equatorial axis. The disk can be wide (for example NGC 7009) or very narrow (Hourglass). The axial ratio can be very high (such as for M2-9) or more close to one (M 27). Finally, we can see difference between the mirror symmetric (M2-9) and the rotation symmetric (NGC 6543a) densities. With these three parameters, we can

define the special characteristics of the disk type planetary nebulae. **NGC 2867: Irregular.** The shape of NGC 2867 is so irregular, that we can not classify it as a certain type.

A still open problem is to fit these qualitative descriptions into quantitative functions.

Chapter 6

Conclusion and Discussion

6.1 Summary

We tried to solve the problem of an asymmetric shock wave through the inhomogeneous interstellar medium. The propagation of the shock wave is described by equation (2.14) in three dimensions with the simplification in 2-d polar coordinates (2.11) or 2-d Euclidean coordinates (3.1). We reproduced the original work by [Kompaneets, 1960] and [Icke, 1988], who gave solutions for special cases of the acceleration parameter A . Our contribution can be divided into two parts: 1. Plain solving the shock wave equation for a given A ; 2. Calculate the original A for a given shock wave.

In the first part, we solved the equation for several test-functions for A . Two of them had an analytic solution, namely $A = \text{constant}$ and $A \propto r^2$. For two functions, of the form $A = r^2/(\theta^i + 1)$ for $i = 1, 2$, the solution can be approximated analytically. The two functions that were physically the most interesting, namely the Gaussian and the Arctans, could only be solved numerically. When switching to toroidal coordinates, we get physically beautiful results such as a model for the Red Rectangle. In three dimensions we obtained an analytic solution when A is constant.

By inverting the two-dimensional polar equation (2.11), one gets a relationship between the shock wave and the initial density profile (5.2). We use a numerical model to compute the density profile for twelve known planetary nebula. That led to a qualitative classification into the ellipsoidal, two-stream and irregular nebula. Inserting some test functions for r into equation (5.2) shows the existence of a extraordinary 'bump' in the density function.

6.2 Discussion

The research, at this point, leaves a few questions unanswered:

1. The construction of the general equation is quite clear. However, as can be seen in appendix A, we can still try to solve the corresponding characteristic system of differential equations.
2. A toroidal density function is interesting but difficult and can be investigated further.
3. We encountered a few test functions for which the equation can be solved. We were not able to solve most of them however. The general behavior on when the equation is solvable and when not is still unclear.
4. In using observations of planetary nebula, we computed the original density function for 11 planetary nebulae. We therefore used the assumption that $\rho = \rho^*(\theta)/r^2$. Perhaps this assumption is not correct.
5. We made a qualitative classification of the PN's into four categories. Does this classification still holds when we observe more PN's?
6. The qualitative classification is not formulated quantitatively, with density formulas for each category.
7. What is the physical background for the various density profiles?
8. When calculating the density distribution for a given shape of the shock wave we get a strange clover like form in the density profile for a strong hourglass shape of the shock wave. How do these clovers form, and do they make any sense, physically? Or is the assumption that $dr/dt \propto r$ incorrect?
9. We did not consider radiative effects in shock waves. For older nebula where these effects dominate our work must be extended.
10. We did not correct for the angle at which we observe the planetary nebula. Thereby comes the uncertainty whether the observed shock wave is equal to the 'real' shock wave.

Bibliography

- [Arfken,1970] *Toroidal Coordinates (ξ , η , ϕ). 2.13 in Mathematical Methods for Physicists*, 2nd ed. Orlando, FL: Academic Press, pp. **112-115**
- [Carroll & Ostlie, 1995] *An Introduction to Modern Astrophysics*, Addison Wesley, New York
- [Courant & Hilbert, 1962] *Methods of Mathematical Physics*, Interscience Publishers, New York
- [Eckhaus et al, 1998] *Partiële differentiaalvergelijkingen*, Universiteit Utrecht, Utrecht
- [Evans, 1998] *Partial differential equations*, American Mathematical Society, Providence (Rhode Island)
- [Icke, 1988] *Blowing bubbles*, A&A **202**, 177
- [Icke, 1989] *The Evolution of Planetary nebulae. III. Position-Velocity images of butterfly-type nebulae*, Astron. J., **97 (2)**, 462
- [Icke et al, 1992] *Collimation of astrophysical jets by inertial confinement*, Nature **355**, 524
- [Icke, 2003] *Blowing Up Warped Disks*, A&A **405**, L11
- [Kompaneets, 1960] *A point explosion in an homogeneous atmosphere*, Dokl. Akad. Nauk. SSSR **130**, 46
- [Moon & Spencer,1961] *Field Theory for Engineers*, Van Nostrand Company, Princeton (New Jersey)
- [Rijkhorst et al, 2004] *Three-dimensional Adaptive Mesh Refinement Simulations of Point-Symmetric Nebulae*, ASPC **313**, 472

- [Vuik et al, 2004] *Numerieke Methoden voor Differentiaalvergelijkingen*, TU Delft, The Netherlands
- [Van Winckel & Cohen, 1999] <http://hubblesite.org/newscenter/newsdesk/archive/releases/2004/11/image/a>
- [Zel'dovich & Raizer, 2002] *Physics of Shock Waves and High-Temperature Hydrodynamic Phenomena*, Dover Publications Inc., Mineola (New York)

Appendix A

Theory of Envelopes

In general, a differential equation in two parameters can be described by

$$F(\theta, t, r, p, q) = 0. \tag{A.1}$$

where $p = \frac{\partial r}{\partial \theta}$ and $q = \frac{\partial r}{\partial t}$. We assume that F is continuous and has continuous first derivatives with respect to all its five arguments.

A.1 The Monge Cone

In order to get a better view on the geometrical aspect of solving the differential equation, we introduce the concept of the Monge cone.

Let us consider the (θ, t, r) -space. The solution of equation (A.1) is a two-dimensional surface in this space. This surface is called the **integral surface** \mathcal{I} .

For every point $P \in (\theta, t, r)$ -space equation (A.1) reduces to a relationship between p and q . The relationship can be represented in a parametric form: $p = p(\lambda)$ and $q = q(\lambda)$. This gives for P a family of allowed directions. We can now look along a given direction and consider what (θ, t, r) are for a certain distance σ . This gives

$$\frac{dr}{d\sigma} = \frac{dr}{d\theta} \frac{d\theta}{d\sigma} + \frac{dr}{dt} \frac{dt}{d\sigma} = p(\lambda) \frac{d\theta}{d\sigma} + q(\lambda) \frac{dt}{d\sigma}.$$

and differentiating this with respect to λ leads to

$$0 = p'(\lambda) \frac{d\theta}{d\sigma} + q'(\lambda) \frac{dt}{d\sigma}.$$

It turns out to be useful to differentiate F with respect to λ . We then get

$$F_p p'(\lambda) + F_q q'(\lambda) = 0.$$

Comparing these results gives a relationship between $d\theta$, dt and dr at a certain point P :

$$d\theta : dt : dr = F_p : F_q : (pF_p + qF_q). \quad (\text{A.2})$$

This concept of a 'family of directions' for a certain point P can be formalized using the definition of a Monge cone.

Definition A.1.1 Consider equation (A.1) and a point $P \in (\theta, t, r)$ -space. At this point we can choose p, q such that $F = 0$. This p, q gives us a direction since p, q are derivatives of r . This direction is called a **characteristic direction** and satisfies equation (A.2). The family of characteristic directions is dependent on one parameter λ and is called the **Monge cone**.

We can say that at point P the characteristic directions are the 'permitted' directions. It follows that at every point P the integral surface \mathcal{I} touches the local Monge cone. We can reverse this statement.

Theorem A.1.1 Suppose we have a surface \mathcal{J} in the (θ, t, r) -space and for every $P \in \mathcal{J}$ we have that \mathcal{J} touches the corresponding local Monge cone. Then \mathcal{J} is a solution of equation (A.1).

The proof is trivial since at every point the surface satisfies $F = 0$ by the definition of the Monge cone. The geometric interpretation of solving (A.1) is thus to form an integral surface that touches the Monge cone at each point.

A.2 Envelopes

Suppose now we have a set of solutions

$$r = f(\theta, t, E). \quad (\text{A.3})$$

where E is the free parameter in the set. We can define for such a set the concept of an envelope.

Definition A.2.1 An **envelope** is a function $\psi(\theta, t)$ that is defined on a set of functions $f(\theta, t, E)$ for which $\forall(\theta, t) \exists E_{(\theta, t)}$ such that $\psi(\theta, t) = f(\theta, t, E_{(\theta, t)})$, $\psi_\theta(\theta, t) = f_\theta(\theta, t, E_{(\theta, t)})$ and $\psi_t(\theta, t) = f_t(\theta, t, E_{(\theta, t)})$.

If we have f to be a set of solutions of equation (A.1), we know that for every E, θ and t the function satisfies $F(\theta, t, r, p, q) = 0$. But since the first derivatives of the functions are equal to the first derivatives of the envelope, so the all points on the envelope also satisfy $F = 0$.

Theorem A.2.1 *If every function of the family $f(\theta, t, E)$ is a solution of the first order differential equation $F(\theta, t, r, p, q) = 0$, then the envelope $\psi(\theta, t)$ is also a solution.*

We can derive the analytic form of the envelope. What we want is a function $E(\theta, t)$ such that

$$\psi(\theta, t) = f(\theta, t, E(\theta, t)).$$

When differentiating this equation with respect to θ and to t , we get

$$\begin{aligned}\psi_\theta = r_\theta &= f_\theta + f_E E_\theta = f_\theta \\ \psi_t = r_t &= f_t + f_E E_t = f_t.\end{aligned}$$

This is only possible when either $E_\theta = E_t = 0$ or is $f_E = 0$. Since we explicitly demanded that E depends on θ and t , we see that the envelope must be constructed using $f_E = 0$.

Theorem A.2.2 *Consider a family of functions $f(\theta, t, E)$. The envelope is obtained by solving*

$$\frac{\partial f}{\partial E} = 0$$

for a function $E(\theta, t)$.

We now know how to construct the envelope and that it is a solution of the first order partial differential equation. The question remains how to get the family of functions.

A.3 Complete integral

Often, the differential equation (A.1) can be directly integrated resulting in a function that depends on two mutually independent parameters E and b :

$$r = r(\theta, t, E, b).$$

Definition A.3.1 *A complete integral is a two-parameter family of solutions of the differential equation (A.1), where the two parameters are independent of each other.*

From this two-parameter set of solutions we can select an one-parameter set by setting $b = g(E)$. In the case when F does not explicitly depends on r , we can write the complete integral in the form $r(\theta, t, E) + g(E)$. In this case, the form of $g(E)$ is defined by the initial conditions. For example, Icke suggested that $g(E) = 0$. In general, the envelope as described in the previous section, can now be obtained solving the equation

$$r_E + g'(E) = 0.$$

Physically, we can say that we are interested in the shock front. That is, we only want to know the outer boundary of this shock, no matter the different parameter E . We can therefore say that the envelope of the complete integral is the physical solution of our differential equation.

A.4 Basic Theory on First Order PDE's

We can use the concept of the Monge cone to make curves through the (θ, t, r) -space that have at each point a characteristic direction.

Definition A.4.1 Consider equation (A.1). A **focal curve** is a curve through the (θ, t, r) -space that has at each point a characteristic direction. The curve satisfies the equations, following equation (A.2),

$$\frac{d\theta}{ds} = F_p, \frac{dt}{ds} = F_q, \frac{dr}{ds} = pF_p + qF_q \quad (\text{A.4})$$

for the curve parameter s .

Note the special property of the integral surface: *Any curve through the integral surface is an focal curve.* However, the reverse is not true. There are only three equations, stated in definition A.4.1, that describe a focal curve. The integral surface is described by five parameters (θ, t, r, p, q) , and thus we need another two equations. These equations can be obtained from differentiating $F = 0$ with respect to θ and t :

$$\begin{aligned} F_p p_\theta + F_q q_\theta + F_r p + F_\theta &= 0 \\ F_p p_t + F_q q_t + F_t q + F_t &= 0. \end{aligned}$$

Using the equations (A.4), we get a total of five equations that describe the form of an integral surface.

Definition A.4.2 *The system of five ordinary differential equations that describes the direction of the integral surface is called the **characteristic system of differential equations** (CDE) belonging to the equation (A.1). These equations are:*

$$\frac{d\theta}{ds} = F_p \tag{A.5}$$

$$\frac{dt}{ds} = F_q \tag{A.6}$$

$$\frac{dr}{ds} = pF_p + qF_q \tag{A.7}$$

$$\frac{dp}{ds} = -(pF_r + F_\theta) \tag{A.8}$$

$$\frac{dq}{ds} = -(qF_r + F_t). \tag{A.9}$$

If we use the system from definition A.4.2, we note that this system leads to a solution curve $(\theta(s), t(s), r(s), p(s), q(s))$ in the five-dimensional space. Along this curve, F is constant. The interesting solutions however are these

Definition A.4.3 *Every solution $(\theta(s), t(s), r(s), p(s), q(s))$ of the CDE which also satisfies $F = 0$ will be called a **characteristic strip**. The projection of this strip onto the (θ, t, r) -space is called a **characteristic curve** or a **partial wave**.*

From the derivation of the CDE we know the following theorem that relates the original equation (A.1) to the CDE:

Theorem A.4.1 *In every integral surface \mathcal{I} there exists a one-parameter family of characteristic curves.*

The problem of solving equation (A.1) is now to construct an integral surface out of an family of partial waves. In general, these partial waves can be obtained using the system of characteristic differential equations.

A.5 System of CDE for Kompaneets equation

The equation that describes the shock wave front, (2.11), can be cast in the general form of equation (A.1) by setting:

$$F(\theta, t, r, p, q) = p^2 - A(\theta, r) \left[1 + \frac{q^2}{r^2} \right] = 0. \tag{A.10}$$

The system of characteristic differential equations now becomes:

$$\theta' = 2p \tag{A.11}$$

$$t' = -\frac{2A(\theta, r)}{r^2}q \tag{A.12}$$

$$r' = 2p^2 - \frac{2A(\theta, r)}{r^2}q^2 \tag{A.13}$$

$$p' = (pA_r(\theta, r) + A_\theta(\theta, r)) \left[1 + \frac{q^2}{r^2} \right] - 2pA(\theta, r)\frac{q^2}{r^3} \tag{A.14}$$

$$q' = A_r(\theta, r) \left[q + \frac{q^3}{r^2} \right] - 2A(\theta, r)\frac{q^3}{r^3}. \tag{A.15}$$

These equations must be solved for $F = 0$.

Appendix B

Maple program used to construct the complete integral

```
> restart:
> with(ListTools):
> n := 64:
>
> "Calculates X-values of the envelope":
> Envelope := proc(t)
>   local k,Elist,L,Y:
>   k := 30:
>   Elist := [seq(evalf(1 - (1-sqrt(delta))/k*(i-1)),i=1..(k+1))]:
>   L := [seq(Tcalc(Elist[i],t),i=1..(k+1))]:
>   Y := [seq(max(seq(L[i,p,2],i=1..(k+1))),p=1..(n+1))]:
>   return Transpose([theta,Y])
> end proc:
>
> "Transforms the x-values into radial coordinates":
> Radial := proc(Tabel)
>   return [seq([evalf(exp(Tabel[p,2])*sin(Tabel[p,1])),
>     evalf(exp(Tabel[p,2])*cos(Tabel[p,1]))],p=1..(n+1))]
> end proc:
>
> "Generates list of Theta-points":
> Delta := Pi/2/n:
```

B Maple program used to construct the complete integral

```
> theta := [seq(evalf(i*Delta),i=0..n)]:
> "Define T(E) = int f(E,theta)":
> f := proc(E,theta) return -Re(sqrt(E^2/A(theta)-1)) end proc:
>
> "Calculates the complete integral T(E) for given E and t":
> Tcalc := proc(E,t)
>   local i, Ttable:
>   Ttable := [seq(i,i=0..n)]:
>   Ttable[1] := E*t:
>   for i from 2 to n+1 do
>     Ttable[i] := evalf(Ttable[i-1] +
Delta*f(E,(theta[i]+theta[i-1])/2)):
>   end do:
>   Ttable := Transpose([theta,Ttable]):
>   return Ttable
> end proc:
>
> "Function from Icke 1988":
> delta := 0.5: sigma := evalf(40 * Pi/180):
> A := proc(theta)
>   return (delta + (1-delta)*exp(-theta^2 / sigma^2))
> end proc:
```

To plot a partial wave for constant E at time t use the command:

```
> PLOT(CURVES(Tcalc(E,t)), AXESLABELS('theta','x'),
VIEW(0..1.57,-1.1..0));
```

To plot the x-values of the envelope at time t use:

```
> PLOT(CURVES(Envelope(t)), SCALING(CONSTRAINED));
```

To make a radial plot of the envelope at time t use:

```
> PLOT(CURVES(Radial(Envelope(t))), SCALING(CONSTRAINED));
```

Appendix C

IDL-Program for numerical modeling

C.1 Information

```
pro Informatie, Bestandsnaam
;This function is for the first time reading the image
;Generates a .info-file with all relevant information

;Reads image file
read_jpeg,Bestandsnaam+'.jpg',Afbeelding,/grayscale

;Plot the image and ask for centre and length scale
set_plot,'X'
contour,Afbeelding
print,'Click on the centre of the nebula'
cursor,x0,y0
wait,.5
print,'Now choose the length scale of the nebula'
cursor,x1,y1
Lengte = sqrt((x1-x0)^2+(y1-y0)^2)

;Reads in the size of the image
s = size(Afbeelding)
sx = s[1]
sy = s[2]
```

```
;Stores all information in info = [x-centre,y-centre,length
; scale,x-size,y-size]
info = [long(x0),long(y0),long(Lengte),sx,sy]

;The array is saved in the .info-file
close,1
openw,1,Bestandsnaam+'.info'
printf,1,info
close,1
end
```

C.2 Analyse shock front and calculate A^*

```
;This code reads in an image and computes the shockfront, which
; is saved in a .schok-file
;-Reken: The general command. Arguments: (File, Height of the
; shock wave (0-255), Number of calculations)
;-Laden: Loads the image and the corresponding .info-file,
; stores it in arrays im and info
;-Sterrenfilter: Filters stars from the image. Argument:
; (Image-array)
;-Schok: Calculates the shock front and stores image in .ps
; file and shock contour in .schok-file. Arguments:
; (Image-array, Info-array, Height of the shock wave (0-255),
; File, Number of calculations)
;-Lijnprofiel: Makes a line profile function along a given
; angle. Arg: (Image-array,Info-array,Angle in degrees)
;-Filter: Makes the shock wave 'smooth' by filtering out the
; extreme peaks.
;-Image: Makes a plot of the image.
;Here we calculate  $A^*$ 
;-Revers: Returns  $A^*$  given the shock front r and dr/dtheta
;-Achtpunts: Makes a eight-point central difference
; approximation for dr/dtheta
;-Glad: Smoothens the vector by using the mean of every group
; of elements.

pro Reken,Bestandsnaam,Hoogte,n
  Laden,Bestandsnaam,im,info
```

```
    im = Sterrenfilter(im)
    Schok,im,info,Hoogte,Bestandsnaam,n
end

pro Laden,Bestandsnaam,im,info
    read_jpeg,Bestandsnaam+'.jpg',im,/grayscale
    info = lonarr(5)
    close,1
    openr,1,Bestandsnaam+'.info'
    readf,1,info
    close,1
end

function Sterrenfilter,Afbeelding
    s = size(Afbeelding)
    Kopie = Afbeelding
    for i=0,(s[1]-1) do begin
        for j=0,(s[2]-5) do begin
            Z = $
[Afbeelding(i,j), Afbeelding(i,j+1), Afbeelding(i,j+2), $
Afbeelding(i,j+3), Afbeelding(i,j+4)]
            if (Afbeelding(i,j+2) gt 2*median(Z)) and $
(Afbeelding(i,j+2) gt 50) then Kopie(i,j+2) = median(Z)
        endfor
    endfor
    return,Kopie
end

pro Schok, Afbeelding,Info,Hoogte,Bestandsnaam,n
    ;Here the shock wave will be calculated and saved in an array
    ;The angle theta in column 0 and the radius in column 1
    ;The interval [0,360] will be divided into n pieces
    ;For each angle will a line profile be made
    ;The shock front is the place where the intensity is more
    ;than the Height of the shock wave
    ;An image will be plotted in a .ps-file
    Theta = findgen(n)/n*360
    r = fltarr(n)
    for i=0,(n-1) do begin
        Z = lijnprofiel(Afbeelding,Info,Theta(i))
```

```
    ;Checking the line profile until r(i)<Hoogte
    r(i) = 0
    repeat r(i) = (r(i) + 1) until ((hoogte gt Z(r(i))) or (r(i) gt Info(2)))
endfor
;Smoothen r
r = Superglad(r,9)
;First calculate the derivative
D = Superglad(Achtpunts(r),9)
;The acceleration parameter A
A = Revers(r,D)
;The density and normalize it
rho = 1 / A
rho = rho / Max(rho)
rho = rho * Max(r) / 2
;Save the information in .schok and .a file
close,1
openw,1,Bestandsnaam+'.schok'
printf,1,n/10,r
close,1
close,1
openw,1,Bestandsnaam+'.a'
printf,1,n/10,A
close,1
;Adds 1 point to get an continuous picture
r2 = fltarr(n/10+1)
for i=0,(n/10-1) do r2(i) = r(i)
r2(n/10) = r(0)
rho2 = fltarr(n/10+1)
for i=0,(n/10-1) do rho2(i) = rho(i)
rho2(n/10) = rho(0)
;Defines the theta-vector
Theta = findgen(n/10+1)/n*3600
Theta(n/10) = Theta(0)
;Now make the vectors that should be plotted
X = float(r2*cos(Theta/360*6.283185307) + Info[0])
Y = float(r2*sin(Theta/360*6.283185307) + Info[1])
Xrho = float(rho2*cos(Theta/360*6.283185307) + Info[0])
Yrho = float(rho2*sin(Theta/360*6.283185307) + Info[1])
;Start plotting and save it in .ps file
loadct,1
```

```
set_plot,'ps'  
device, filename=Bestandsnaam+'.ps',/color,/landscape  
  image,Afbeelding  
  loadct,3  
  oplot,X,Y,thick=3,color=100  
  oplot,Xrho,Yrho,thick=3,color=200  
device,/close  
set_plot,'X'  
end  
  
function LijnProfiel, Afbeelding, Info, Hoek  
  ;Makes a line profile in the direction Hoek from the center  
  Lengte = Info(2)  
  Hoek = Hoek * 6.283185307 / 360  
  ;In the vectors Xlijst and Ylijst will the intensity be  
  ;stored along the line.  
  Xlijst = long(Info(0) + $  
(Lengte*cos(Hoek))*findgen(Lengte)/(Lengte-1))  
  Ylijst = long(Info(1) + $  
(Lengte*sin(Hoek))*findgen(Lengte)/(Lengte-1))  
  ;Returns the line profile  
  return,long(Afbeelding[Xlijst+long(Ylijst)*Info[3]])  
end  
  
function Filter,Tabel,Factor  
  ;This functions takes a Factor elements in the array and  
  ; returns the median  
  ;Thus resulting in an array Factor times smaller  
  Temp = fltarr(Factor)  
  s = size(Tabel)  
  sx = s[1]  
  Lengte = long(sx/Factor)  
  Result = fltarr(Lengte)  
  for i=0,(Lengte-1) do begin  
    for j=0,(Factor-1) do Temp(j)=Tabel(i*Factor+j)  
    Result(i) = median(Temp)  
  endfor  
  return,Result  
end
```



```
pro image, a
;Special function to plot the image in .ps
on_error,2 ;Return to caller if an error occurs
sz = size(a) ;Size of image
contour,[[0,0],[1,1]],/nodata, xstyle=4, ystyle = 4

;Get size of window in device units
px = !x.window * !d.x_vsize
py = !y.window * !d.y_vsize
swx = px[1]-px[0] ;Size in x in device units
swy = py[1]-py[0] ;Size in Y
six = float(sz[1]) ;Image sizes
siy = float(sz[2])
aspi = six / siy ;Image aspect ratio
aspw = swx / swy ;Window aspect ratio
f = aspi / aspw ;Ratio of aspect ratios

if (!d.flags and 1) ne 0 then begin ;Scalable pixels?
  if f ge 1.0 then swy = swy / f else swx = swx * f
  tvscl,a,px[0],py[0],xsize = swx, ysize = swy, /device
endif else begin ;Not scalable pixels
  if keyword_set(aspect) then begin
    if f ge 1.0 then swy = swy / f else swx = swx * f
  endif ;aspect
  tv,poly_2d(bytscl(a),[[0,0],[six/swx,0]], $
[[0,siy/swy],[0,0]],keyword_set(interp),swx,swy),px[0],py[0]
endelse ;window_scale

  contour,a,/noerase,/xst,/yst,pos = [px[0],py[0], $
px[0]+swx,py[0]+swy],/dev,levels=[0]
  return
end

function Revers,Straal,Diff
;Uses  $A = r^2 / (1 + (r'/r)^2)$ 
A = (Straal^2 / (1 + (Diff/Straal)^2))
m = Max(A)
return, A/m
end
```

```

function Achtpunts,Tabel
  s = size(Tabel)
  sx = s[1]
  ;Defines the interval
  D = fltarr(sx)
  h = float(6.283185308/sx)
  ;Calculating the derivative for all point
  for i=4,(sx-5) do begin
    D(i) = (Tabel(i-4)/280 - 4/105*Tabel(i-3) + Tabel(i-2)/5 $
- 4*Tabel(i-1)/5 - Tabel(i+4)/280 + 4/105*Tabel(i+3) - $
Tabel(i+2)/5 + 4*Tabel(i+1)/5)/h
  endfor
  D(0) = (Tabel(sx-4)/280 - 4/105*Tabel(sx-3) + Tabel(sx-2)/5 $
- 4*Tabel(sx-1)/5 - Tabel(4)/280 + 4/105*Tabel(3) - $
Tabel(2)/5 + 4*Tabel(1)/5)/h
  D(1) = (Tabel(sx-3)/280 - 4/105*Tabel(sx-2) + Tabel(sx-1)/5 $
- 4*Tabel(0)/5 - Tabel(5)/280 + 4/105*Tabel(4) - Tabel(3)/5 $
+ 4*Tabel(2)/5)/h
  D(2) = (Tabel(sx-2)/280 - 4/105*Tabel(sx-1) + Tabel(0)/5 $
- 4*Tabel(1)/5 - Tabel(6)/280 + 4/105*Tabel(5) - Tabel(4)/5 $
+ 4*Tabel(3)/5)/h
  D(3) = (Tabel(sx-1)/280 - 4/105*Tabel(0) + Tabel(1)/5 $
- 4*Tabel(2)/5 - Tabel(7)/280 + 4/105*Tabel(6) - Tabel(5)/5 $
+ 4*Tabel(4)/5)/h
  D(sx-1) = (Tabel(sx-5)/280 - 4/105*Tabel(sx-4) + $
Tabel(sx-3)/5 - 4*Tabel(sx-2)/5 - Tabel(3)/280 + $
4/105*Tabel(2) - Tabel(1)/5 + 4*Tabel(0)/5)/h
  D(sx-2) = (Tabel(sx-6)/280 - 4/105*Tabel(sx-5) $
+ Tabel(sx-4)/5 - 4*Tabel(sx-3)/5 - Tabel(2)/280 $
+ 4/105*Tabel(1) - Tabel(0)/5 + 4*Tabel(sx-1)/5)/h
  D(sx-3) = (Tabel(sx-7)/280 - 4/105*Tabel(sx-6) + $
Tabel(sx-5)/5 - 4*Tabel(sx-4)/5 - Tabel(1)/280 + $
4/105*Tabel(0) - Tabel(sx-1)/5 + 4*Tabel(sx-2)/5)/h
  D(sx-4) = (Tabel(sx-8)/280 - 4/105*Tabel(sx-7) + $
Tabel(sx-6)/5 - 4*Tabel(sx-5)/5 - Tabel(0)/280 + $
4/105*Tabel(sx-1) - Tabel(sx-2)/5 + 4*Tabel(sx-3)/5)/h
  return,D
end

```

```

function Superglad,Tabel,n

```

C IDL-Program for numerical modelling of an analyse shock front and calculate A^*

```
;Smoothens the vector by filtering out the peaks
s = size(Tabel)
sx=s[1]
Result=Tabel
Temp=fltarr(n)
n1 = (n-1)/2
for i=n1,(sx-1-n1) do begin
  for j=0,(n-1) do Temp(j) = Tabel(i-n1+j)
  m = mean(Temp)
  Result(i) = m
endfor
return,Result
end
```

Appendix D

Images of Planetary Nebulae

The picture is in blue-scale. The red line indicates the outer shock wave front as calculated by the program. The yellow line corresponds to the density profile. The description for each class of PN's can be found in section 5.

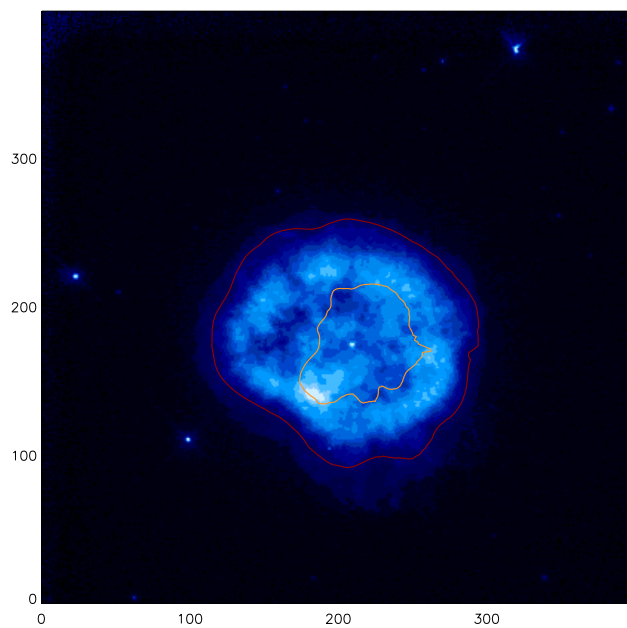

NGC 2867 (Irregular)

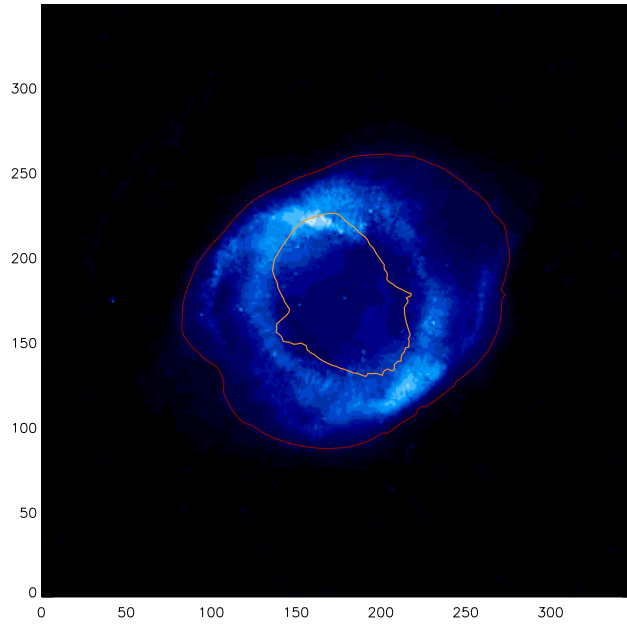

Helix Nebula (Ellipsoidal)

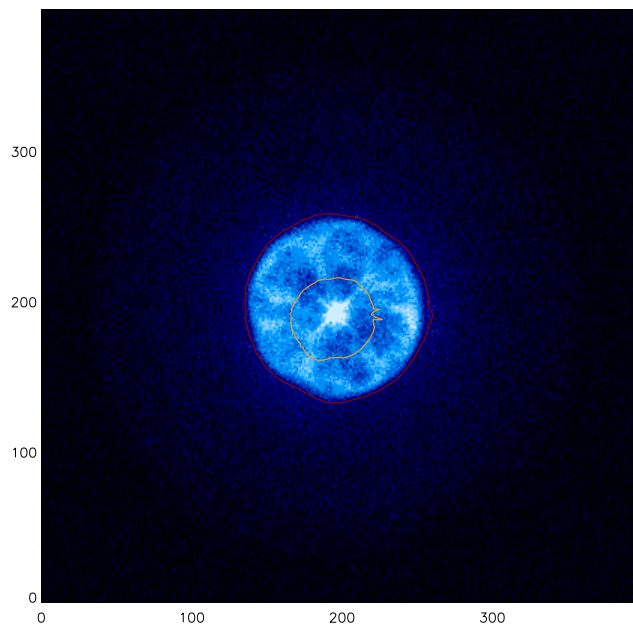

IC 3568 (Ellipsoidal)

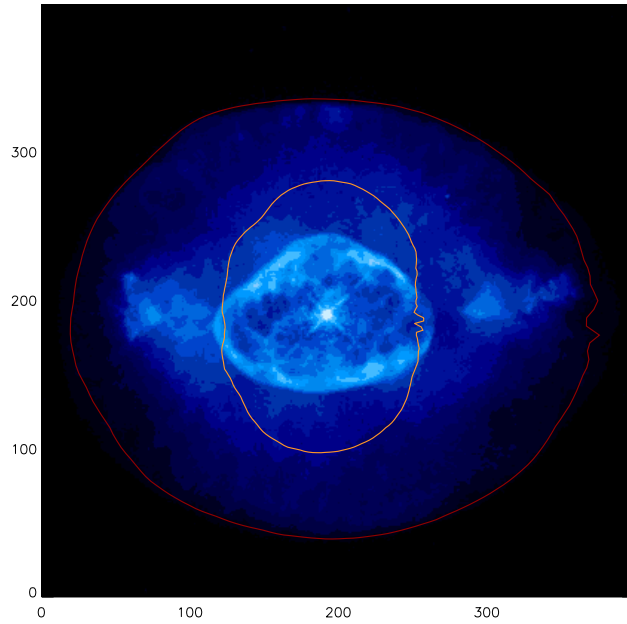

NGC 6826 (Ellipsoidal)

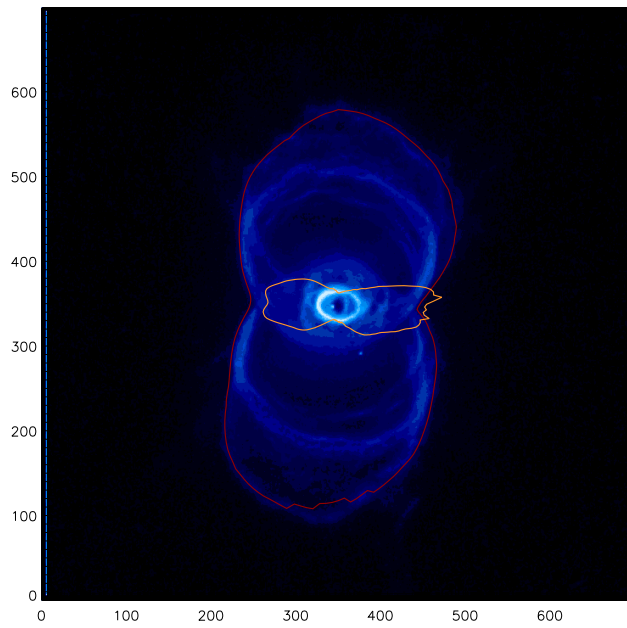

Hourglass Nebula (Disk)

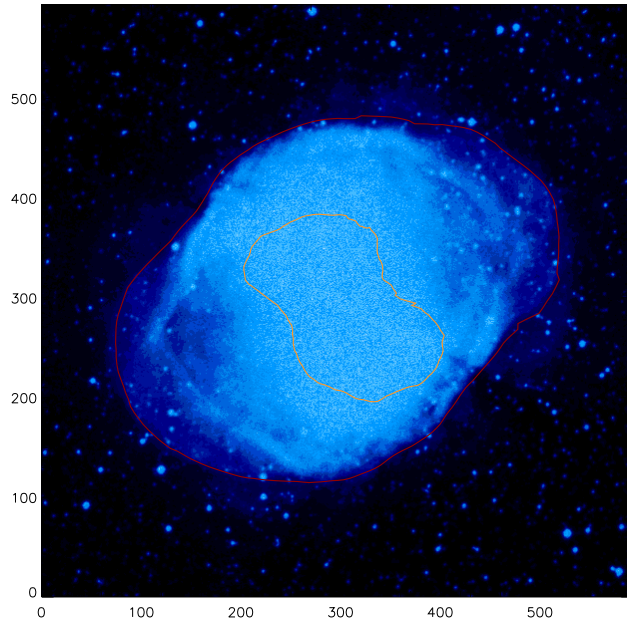

M 27 alias NGC 6853 (Disk)

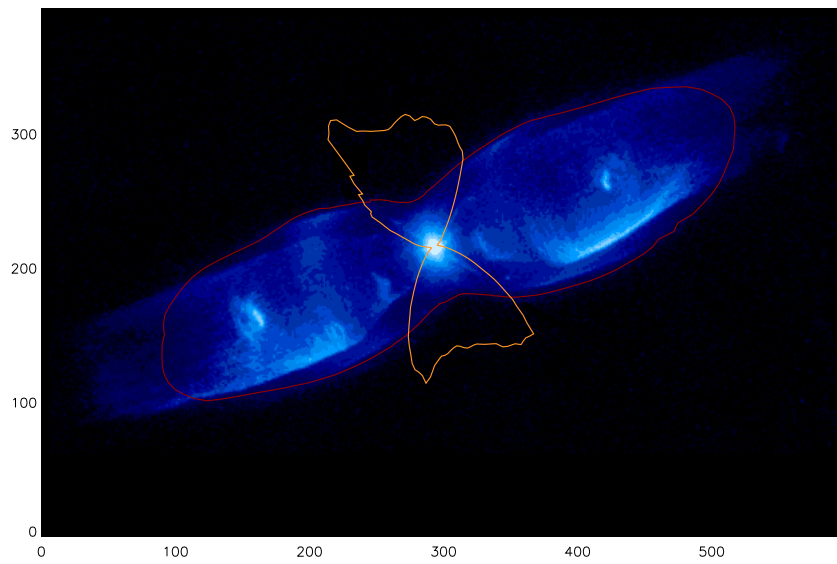

M2-9 (Disk)

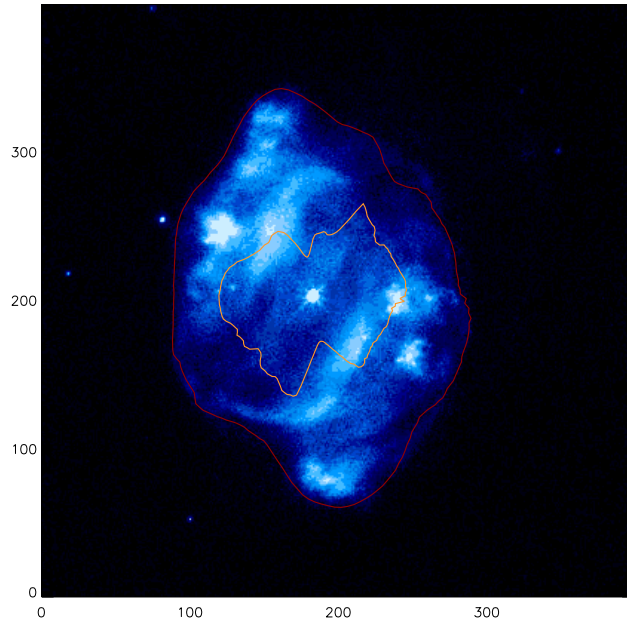

NGC 5307 (Disk)

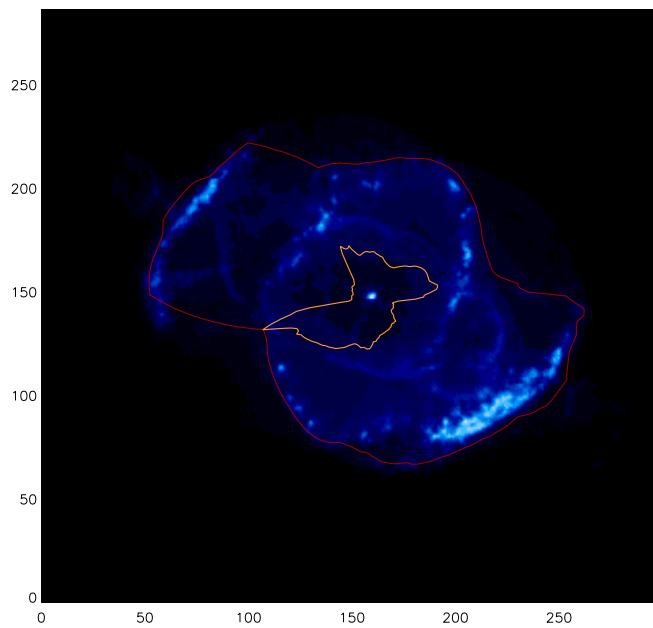

NGC 6543a (Disk)

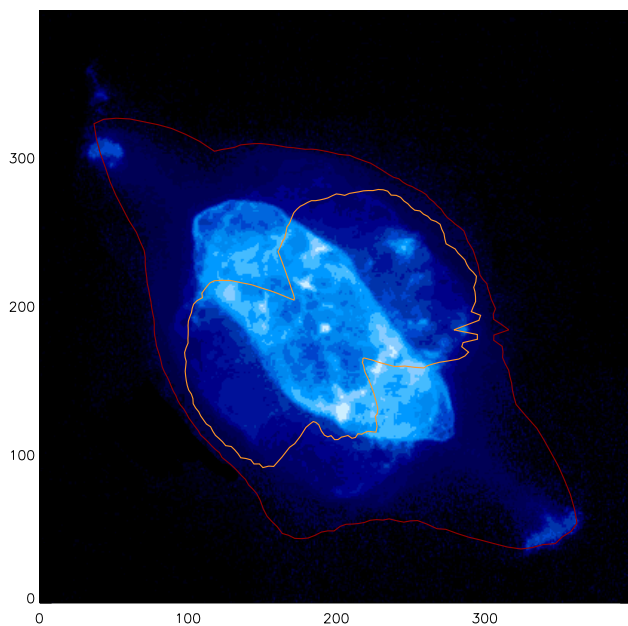

NGC 7009 (Disk)

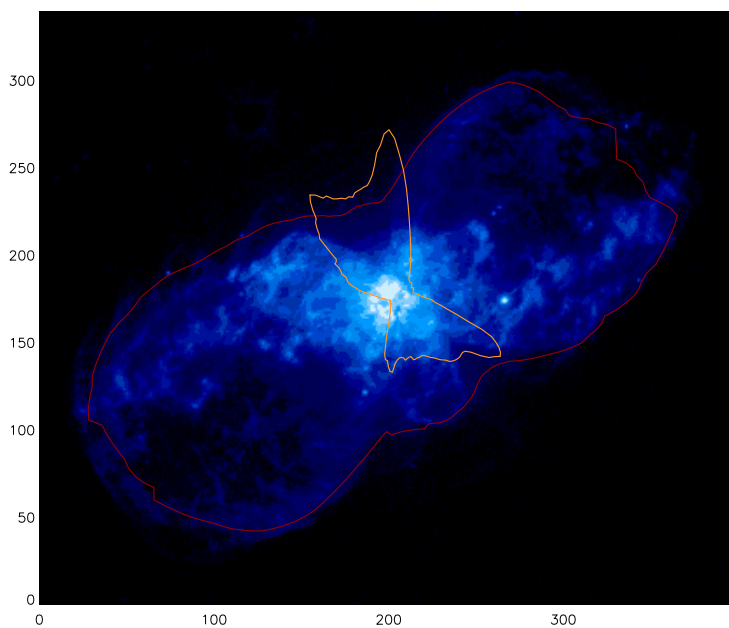

Hubble 5 (Disk)

D.1 The Red Rectangle

Hubble Space Telescope image of the Red Rectangle (HD 44179). The numerical calculations for equation (4.64) with $\alpha = 1$, $\sigma = 2$, $\eta = 3$ and $t = 1.6$ appear to fit quite good. The observation is by [Van Winckel & Cohen, 1999].

