



Universiteit
Leiden
The Netherlands

Reduction of Return on Investment Time and Failures in the Distribution Grid by Measuring Temperature and Current on Cable Joints

Jansen, N.

Citation

Jansen, N. (2014). *Reduction of Return on Investment Time and Failures in the Distribution Grid by Measuring Temperature and Current on Cable Joints*.

Version: Not Applicable (or Unknown)

License: [License to inclusion and publication of a Bachelor or Master thesis in the Leiden University Student Repository](#)

Downloaded from: <https://hdl.handle.net/1887/3597239>

Note: To cite this publication please use the final published version (if applicable).



Reduction of Return on Investment Time and Failures in the Distribution Grid by Measuring Temperature and Current on Cable Joints

Master thesis
Defended on July 4th, 2014
at the Mathematical Institute of Leiden University

Author:
Niels JANSEN
Studentnumber:
0837237

Supervisors:
Dr. F. SPIEKSMAN
Dr. ir. R. VELTHUIJS

Abstract

The structure of the power grid has been unchanged since the introduction of AC power. With the introduction of clean energy we see that the purpose of the grid changes. Instead of only having large power plants, we now have many small generators scattered over the grid. The power network was not designed for this amount of distributed generation and our ever increasing demand for energy. Therefore we can expect that this trend will lead to an increase of interruptions due to a new kind of failures. In this thesis we will investigate the use of temperature and current measurements to prevent these failures from happening unexpectedly and how we can reduce the return on investment time of cables.

In this thesis we will investigate the distribution system operator and the challenges found in the distribution grid of Westland Infra. We will simulate a small part of the distribution grid. We will evaluate important parameters for the challenges in the grid of Westland Infra and we will develop a proactive maintenance policy to reduce the return on investment time of adding cables in the grid.

Acknowledgements

This thesis is the result of nine months of research. This time made up of 5 months at the Energie Kenniscentrum of the Hanze University of Applied Sciences in Groningen and 4 months at Leiden University. This research was done to complete the master Applied Mathematics at Leiden University. This research could not be done without the help of many people.

First I want to thank my supervisor at the Hanze University of Applied Sciences Rolf Velthuijs. Not only did you introduce me to the research problem, you told me many stories about world of energy. In our meetings you guided and pushed me to make this research interesting without needing knowledge of mathematics. Not only did you guide me in the research, you also guided me through Groningen. I really liked working with you and continuously receiving interesting mails and invites. Without you conducting this research would not have been the same.

I want to continue to thank my second supervisor Floske Spijksma. I came to you to find a research subject in the direction of Operations Research but I found a practical research on power grids. You never made a problem of this practical approach and helped me with the mathematical background and issues. We discussed all the mathematical issues in the research and you pointed out where I should pay attention to. You also showed me the mathematical community and the future possibilities. Lastly I want to thank you for reading and correcting everything I sent you (even on Saturdays).

I also want to thank Wim Mallon. We had several meetings in which your practical view was bombarded at me. You listened to all my talks about the research and did not hesitate to interrupt me to find out all the details. I want to thank you for your driven approach and I will never forget that one should not exceed the limits of a car.

This research would not be possible without the contribution of Westland Infra. I had the possibility to visit them several times and ask all my questions. They also provided the idea for this research and data as input for the simulations. At your company I had the possibility to see a melted joint. You gave the research an extra dimension.

Contents

Abstract	1
Acknowledgements	2
1 Introduction	5
1.1 Motivation	5
1.2 Aim of the research	5
1.3 Thesis outline	6
2 The Power Grid	8
2.1 History of the Power Grid	8
2.2 The power grid of today: production and distribution	9
2.3 Future of the Power Grid	12
3 Operating the distribution grid	14
3.1 Westland Infra	14
3.1.1 Distribution grid of the future	15
3.2 The Distribution System Operator	16
3.3 Distributed Generation	18
3.4 Underground chaos	19
3.4.1 Cables and joints	19
3.5 Overloading of cables: introduction and consequences	22
3.6 Maintenance in the distribution grid	23
4 Modeling the distribution grid	25
4.1 Components and their mathematical representation	25
4.2 Power Flow Analysis	26
4.2.1 One phase power flow model	28
4.2.2 Three phases power flow model	29
4.2.3 Solution method	30
4.3 Modeling of failures	31
4.3.1 Temperature equations and overheating	32
4.4 Model for repairing components	34
4.5 Cost model	35

5	Maintenance models	37
5.1	Measurements and basic equations	37
5.1.1	Residual Grid and input power computation	38
5.2	Proactive maintenance model	39
5.2.1	Stochastic Power Flow Analysis	42
5.3	Reactive maintenance models	45
6	Simulations and Results	46
6.1	Simulation method and first results	46
6.2	Results	54
6.2.1	Cost and failures	54
6.2.2	Return on investment and decisions	56
7	Conclusions and Further Research	60
7.1	Conclusions	60
7.2	Further Research	62

Chapter 1

Introduction

1.1 Motivation

When the first electricity utility opened in 1816, nobody could even imagine the impact electricity would have 200 years later. Nowadays we are used to having a power grid which supplies us with electricity whenever we demand it. We use electricity for traveling, communicating, cooking and even for relaxing. Almost every action we take in a regular day uses electricity in some form. This dependence on electricity is also seen in the cost of interruptions, in 2001 power interruptions costs in the US were estimated at \$79 billion [1]. This big impact on our daily lives makes the power grid an interesting study from almost every point of view.

The power grid has always functioned as a top-down grid. Large power plants produced a great amount of power which was distributed to customers in a large area. However nowadays we see changes in the production of electricity. We have increased the amount of clean energy plants (e.g. wind, solar and hydro). We have also increased the amount of solar panels on our roofs and the amount of small wind farms. Other small production devices have also been increased (e.g. Combined Heat and Power (CHP), small generators). The increase of this distributed generation changes how we use the power grid. The consequences of this change are generally unknown as we have never used the grid in this fashion. This possible change combined with the large impact of the power grid on our daily lives serves as a motivation for this research.

In this research we will focus on the grid of the distribution system operator (DSO) Westland Infra and the challenges that they found operating their distribution grid. Westland Infra already had to deal with a large amount of distributed generation. Therefore we can consider the grid of Westland Infra as a 'grid of the future'. We can expect to see the challenges they found in other parts of the power grid when distributed generation increases. Therefore the case of Westland Infra serves as a basis for this thesis.

The question remains what Applied Mathematics can contribute to the field of power grids and the decisions to be made. In my view Applied Mathematics is about describing real life situations in the language of math. Using this description we can provide insights in the effects of the decisions that can be made. Before making this description, in general a problem is provided and one should fully understand the field that is being described. For that the Hanze University of Applied Sciences gave a direction on the problems that existed in the power grid and allowed a gaze into the world of energy. The aim of the research and the outline of this thesis will be presented in the following sections.

1.2 Aim of the research

In this thesis we will investigate how we can use temperature and current measurements at joints in the distribution grid to determine maintenance actions by the DSO. These actions will consist of replacing

components or adding new cables. We will look at the effects of these actions on the costs of the grid and the number of failures. We formulate the following research question:

1. How can we use temperature and current measurements at joints in the distribution grid to determine maintenance actions and what are the effects on the operating expenses (OPEX) and capital expenses (CAPEX) for the DSO and the number of failures in the distribution grid in the situation of Westland Infra?

We can not answer this question immediately. First we need some understanding on power grids and the processes in a DSO. In this thesis we will first consider the six questions below before we will answer our main research question. All of the subquestions are answered in their respective chapter.

1. What is the power grid, how has it evolved in the past and what are the biggest challenges in the near future?
2. How does a DSO operate the distribution grid and which challenges occurred in the grid of Westland Infra?
3. Can we propose a simple mathematical model of the distribution grid that is accurate enough for simulating the effect of the managerial decisions of the DSO?
5. Can we propose a proactive maintenance model based on measurements in the grid and how can we model the existing reactive maintenance methods at Westland Infra?
6. Can we find and evaluate the effect of the different maintenance models on the OPEX and CAPEX in the distribution grid and the number of failures in the situation of Westland Infra?

1.3 Thesis outline

The structure of the thesis will follow the questions stated above which will all be answered in a different chapter. In Chapter 2 an introduction into the power grid will be made. In Section 2.1 we discuss a short history of the power grid, followed by an extensive description of the current power grid in Section 2.2. At last we will take a look into the future of the power grid in Section 2.3.

In Chapter 3 the reader will find a description of the grid of Westland Infra and an extensive elaboration of the processes within a DSO. Furthermore we will take a detailed look at the challenges that occurred in the grid of Westland Infra. Section 3.1 presents an introduction to the grid of Westland Infra. We continue with a general description of the distribution system operator in Section 3.2. In Section 3.3 we start with describing the challenges at Westland Infra, here we consider distributed generation. We continue with the underground infrastructure in the distribution grid where we focus on describing the cables and cable joints in Section 3.4. Section 3.5 continues with the cables and cable joints. In this section we consider when a cable is overloaded and which consequences follow from overloading. We finish with Section 3.6. Here we glance at the maintenance performed by DSO's in the distribution grid. After this Chapter the reader has an idea of the structure of the distribution grid and some important (possibly future) challenges.

When this point is reached, the reader should have some basic knowledge of the power grid. In Chapter 4 we will continue with constructing the mathematical model which will be used in the simulations. In Section 4.1 a mathematical representation of the components in the distribution grid will be proposed. This representation will be followed by an introduction to power flow analysis in Section 4.2. Section 4.3 will show how we propose to model failures in the power grid. We will propose a general model for repairs in Section 4.4 and we do a cost analysis in Section 4.5.

The reader will be introduced to measurements on cable joints and maintenance models in Chapter 5. We explain the sensors we use and which information we gain from measuring in the grid in Section 5.1. We will continue with proposing a model for proactive maintenance based on optimizing the costs and number of failures in the grid in Section 5.2. Lastly Section 5.3 proposes reactive maintenance models based on existing maintenance rules.

Now that all the ingredients are presented to the reader, Chapter 6 will treat the simulation of the different maintenance models. In Section 6.1 an introduction to the simulation procedure will be made and we will present some first results. In Section 6.2 we present all the important results. We have split this section in results on the costs and the number of failures and results regarding the return on investment time and decisions made by the models.

Chapter 7 will be a summary of everything that has been done. In Section 7.1 an answer will be given to all research questions. Finally in Section 7.2 we propose multiple options for future research.

Chapter 2

The Power Grid

In our daily lives we use many electrical devices. We are accustomed to the fact that we can retrieve electricity on demand, we just have to plug in the device we need and it works. We can do this because of the existence of an extensive infrastructure for producing and transporting electricity. This infrastructure is a complex network that consists of generators, transportation lines and distribution facilities. The power network developed over the course of many years to suit our demand of power leading to the grid that we use nowadays. The power grid evolved to supply our ever increasing demand of electricity and the need for reliable supply. Nowadays the average downtime of a customer in The Netherlands is only 30 minutes per year [2]. In order to maintain this state of reliable power supply a lot has to be invested into the power grid. In The Netherlands approximately 2 billion euro per year is invested in replacement and expansion of the power grid [2]. In this thesis we will focus on investments that are made in the distribution grid. This chapter will continue with the history of the power grid, showing how the grid was founded and how it evolved to our current power network. Furthermore a basic introduction to the power network is presented and we will discuss the future of the power grid.

2.1 History of the Power Grid

The first energy utility founded was not meant for producing electricity. In 1816 the city of Baltimore gave permission to supply the city with coal gas for street lighting. Supplying street lights with gas developed greatly in the following period. In 1826 almost every city and large town in Britain had a gas works, mostly for street lighting [3]. The first electrical energy utility needed some technological improvements to be deployed. The first use of electricity was to provide lighting and when it was possible to provide a steady current, the first electric light companies emerged in 1878. This led in 1879 to the first commercial power station in San Fransisco which supplied users with power for their arc lights.¹ This station was the first utility that sold electricity from a central plant to multiple customers through transmission lines.

When the electricity grid was being developed it had one big competitor, the gas network. This network already started developing in 1816 and there already existed a large infrastructure for gas transport when the electric grid started emerging. The gas companies also acquired contracts from cities to supply the city lighting. In Antwerpen, for example, an electric plant was built in 1880 by the 'Compagnie Générale d'Electricité'. This plant could only be employed for experimental use because the city had given a license to the gas company for city lighting. The Compagnie d'Electricité was not able to manage without the possibility to supply electricity for lighting. Furthermore people had grown accustomed to gas as energy supply. When the electric lighting became available for at home use, gas lighting already made it to the homes and in 1885 a gas mantle was invented which produced a much

¹Arc light was the first practical electric light. An arc lamp produces light by an electric arc. Such an arc is the discharge that occurs when a gas is ionized. A high voltage pulse is needed to create the arc but it can be maintained at a lower voltage.

brighter light and better quality gas was being used for improved and more efficient lighting. Gas also had the profit that it could be used for other purposes such as heating and cooking.

Gas networks had the superior position and infrastructure, but the electric lighting companies eventually had the better product. One of the biggest promoters for electric lighting was Thomas Edison. He also held most of the patents on electric lights. He constructed his own electric grid and based the infrastructure on the gas network, replacing the components with their electric counterparts. The invention of improved electric lights together with the development of the electric infrastructure led to the replacement of gas lighting. The start of the electricity grid was a major transition in the energy supply, but it would certainly not be the last transition.

The second transition also involved Thomas Edison, as the Edison electricity system was fully based on direct current (DC). This sort of current worked well with his type of lights and so he developed all his infrastructure for DC current. The use of direct current has an important drawback, namely the voltage can not be changed easily. This means that machines operating on different voltages should be connected separately to the power plant which led to infrastructural problems. The common voltage for customers was set at 220 Volt for practical and safety reasons. At this voltage transporting a high current leads to significant heat losses. These losses meant that the power should be generated close, less than 2 km, to the consumer. For large cities this implied that there had to be multiple power plants to supply the entire city.

In the same period that the DC grid was emerging, there were developments on alternating currents (AC). Alternating currents could be transformed easily to different voltages and therefore eliminated the drawbacks of direct current. The most important development was the possibility to construct transformers for use in power systems by Lucien Gaulard in 1884. This allowed him to make an AC power transmission system. In 1886 the first AC power system in the world was opened in Massachusetts, funded by George Westinghouse. Later that year the first commercial system was implemented. The biggest drawbacks of the AC grid at that moment was that there did not exist an efficient generator and big cities already invested heavily in DC networks. In 1887 a big improvement on AC generators was made. The first three phase generator was built and in 1888 Nikola Tesla presented his poly phase generator. In collaboration with Westinghouse, Tesla continued to work on this kind of generator and in 1893 the first commercial three phase power installation was realized. From that moment, AC power was able to compete with the infrastructure of the Edison DC system. With technological development AC power proved itself to be more economical and applicable. In the long run AC power was the victor in this 'War of Currents'. In the early years of the energy distribution grid we have already seen two major transitions. These transitions were followed by developments that increased the scale of the grid and led to the electricity distribution we are now used to. We can note from all transitions in the power grid that they emerge from changing demands of the consumer. This is mostly solved by technical enhancements which have to compete with the existing infrastructure. Only when the gains of a better system outweigh the investment costs of implementing the new technology a transition is made.

2.2 The power grid of today: production and distribution

In our current society we have become accustomed to a constant supply of electricity. To make this possible, an extensive infrastructure exists for supplying electricity to the variety of electrical devices we use. As every journey has a beginning so does the story of power supply. It all starts with the production of electricity. The production of electricity can be separated into two types, centralized and distributed generation.

With centralized generation we mean large generation facilities that each produce a great amount of electricity which is then distributed to a large number of consumers. Centralized generation facilities are for example fossil power plants, nuclear plants, hydro power plants and wind power fields. These facilities benefit from the cost-effectiveness of production on a large scale. The infrastructure corresponding to centralized generation is a top down grid. Such a grid consists of several stages where every stage is on a lower voltage and reaches less consumers. These big facilities have several drawbacks. They are hard to shift in production, need great investments to emerge and have constraints on placement (environmental, social, and available space).

Distributed generation facilities are small production installations which are scattered over the grid. These installations are for instance wind turbines, solar panels and CHP's. This production capacity is placed at industries or individuals which usually are also consumers of electricity. Therefore the produced electricity feeds into a low part of the infrastructure, which operates at a low voltage and is made for a low consumption of power compared to the total production of a central generation facility. The benefits of distributed generation is that it is flexible, is mostly renewable, has limited environmental drawbacks, the installations have low investment costs compared to a large facility and there are almost no constraints on placement.

The central generating facilities all use some kind of energy source to power a generator. This energy source can be a fossil fuel, potential energy or wind power. The generator produces alternating current power. Alternating current means that the resulting output of the generation is a sinusoidal, which is created due to the spinning of the generator. We can then write the voltage and current created by the generator as

$$V(t) = V_{\max} \cos(\omega t + \delta_1), \quad (2.1)$$

$$I(t) = I_{\max} \cos(\omega t + \delta_2). \quad (2.2)$$

Using alternating current means that we have to change the way we think about power. In the direct current situation we have that the power produced is a constant, $P_{DC} = V_{DC}I_{DC}$. The power produced in an alternating current generator however is not that simple. We can calculate this power by multiplying (2.1) and (2.2). In order to simplify calculations we choose the reference time such that $V(t) = V_{\max} \cos(\omega t)$ and $I(t) = I_{\max} \cos(\omega t - \varphi)$, where $\varphi = \delta_1 - \delta_2$. The angle φ is called the power factor angle and $\cos(\varphi)$ is known as the power factor. We can then find an expression for the power produced by the generator

$$\begin{aligned} P(t) &= V(t)I(t) \\ &= V_{\max} \cos(\omega t)I_{\max} \cos(\omega t - \varphi) \\ &= \frac{1}{2}V_{\max}I_{\max} \cos(\varphi)[1 + \cos(2\omega t)] + \frac{1}{2}V_{\max}I_{\max} \sin(\varphi) \sin(2\omega t) \\ &= |V||I| \cos(\varphi)[1 + \cos(2\omega t)] + |V||I| \sin(\varphi) \sin(2\omega t). \end{aligned} \quad (2.3)$$

In the third step we have made the substitutions $|V| = \frac{V_{\max}}{\sqrt{2}}$ and $|I| = \frac{I_{\max}}{\sqrt{2}}$. We now define real and reactive power as the magnitudes of the sinusoidal waves produced by the generator,

$$P = |V||I| \cos(\varphi), \quad (2.4)$$

$$Q = |V||I| \sin(\varphi). \quad (2.5)$$

Electrical devices consume both real and reactive power. The real, active or resistive power P is used directly by the device (e.g. to create heat or light). The reactive or imaginary power Q is stored by the electrical device (e.g. in an electromagnetic field) and returned later. The power factor of a circuit gives the relation between real and reactive power. In a circuit that induces purely real loads the power factor $\cos(\varphi) = 1$, in this case there is no phase difference between the voltage and current. When the load is purely reactive we have power factor $\cos(\varphi) = 0$ and the phase difference between the voltage and the current is $\frac{\pi}{2}$. As we have mentioned, reactive power is stored and returned to the grid on a later time. We can see this property from integrating the total power over one period $T = \frac{2\pi}{\omega}$ and see that the total power consumption equals

$$\frac{1}{T} \int_0^T P(t)dt = \frac{1}{T} \int_0^T [P(1 + \cos(2\omega t)) + Q \sin(2\omega t)]dt = P. \quad (2.6)$$

This equation shows that the reactive power is not consumed in the circuit. The consumer is only charged for the real power consumed. Therefore in the power grid it is wanted that the reactive load is low and thus the power factor is close to 1.

Most large generating facilities produce three phase power. Three phase power is created by combining three of the sine waves as in equations (2.1) and (2.2) with a phase difference of 120 degrees.

The waves are produced by the same generator and therefore they have the same frequency, which is mostly 50 or 60 Hz. The three phase power flow is illustrated in Figure 1, where the voltage profile is shown for the three different phases. In this figure we have shown one period of a 50 Hz wave with $V_{\max} = 1$. Three phase power is especially beneficial for self starting induction motors because, as seen

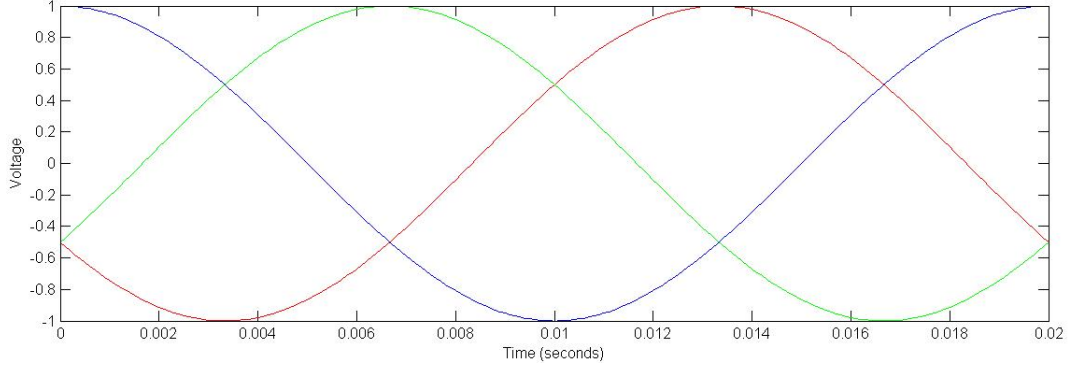

Figure 1: Voltage profile of a three phase power flow with $V_{\max} = 1$ and a frequency of 50 Hz. The blue line has no phase shift, the green line is shifted 120 degrees and the red line has a 240 degrees phase shift.

in Figure 1, always one of the three waves is close to its maximum. The application of three phase power can also be seen in the charging of electrical vehicles, the charging time of such a vehicle is a lot lower when connected to an industrial three phase power source as opposed to the one phase power source a normal consumer has access to. Another benefit of three phase power is that we can create a new line by connecting the three phases. The voltage of this line is

$$\begin{aligned}
 V(t) &= V_1(t) + V_2(t) + V_3(t) \\
 &= V_{\max}(\cos(\omega t) + \cos(\omega t + \frac{2\pi}{3}) + \cos(\omega t + \frac{4\pi}{3})) \\
 &= 0,
 \end{aligned} \tag{2.7}$$

thus connecting the three phase lines together creates a neutral power line.

After the electricity is produced, it is distributed to the consumer. For electricity produced by a centralized generator, this happens in a step down scheme. In every step the voltage and the total power is decreased, Figure 2 gives a schematic view of the distribution of electricity and the step down structure. We can follow the journey of electricity produced in a centralized generator and transported to the microwave at a regular household. After the electricity is produced as three phase power in the generation facility the voltage is increased to the level of the high-voltage grid. The voltage is increased because the power is about to enter the transmission grid covering large distances which implies that significant power losses exist. These power losses are proportional to the current squared and thus the inverse of the voltage squared. Increasing the voltage of the electricity will decrease the losses in the transmission grid substantially. The transmission system operator (TSO), which in The Netherlands is TenneT, is responsible for the transmission grid. The tasks of TenneT are, to transport electricity on the high voltage grid and to control and guard the balance between supply and demand [4]. The TSO needs to balance the supply and demand in the transmission grid, which means that electricity entering the grid should also leave the grid. In order to make it possible to balance the power in the transmission grid, TenneT demands information on the supply and demand in the lower regions of the grid. Every region has a company that is Program Responsible (PR). This company is assigned to make programs of the expected supply and demand on a part of the grid. These programs consist of blocks of 15 minutes and have to be communicated to the TSO one day beforehand. The actual supply and demand of a PR is measured by a data supervisor and based on this the national operator determines the difference between the program and reality. When this difference leads to problems in balancing the grid, the transmission system operator has to take actions to remove the imbalance. This can for instance be done by congestion management. Congestion management means that parties will get a reward for consuming or producing

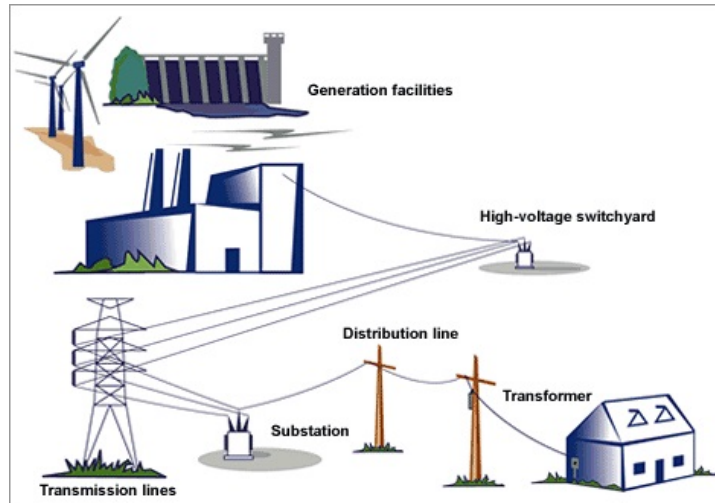

Figure 2: Schematic view of the distribution of electricity.

a different amount of energy than expected. The PR is financially responsible for the difference in the program and the actual supply. A PR has several methods to buy or sell energy in order to balance his own program. This can be done by trading at the electricity stock exchange (APX-Endex), directly with other PR's, with electricity producers or with foreign countries. The balancing of power implies that all the electricity within the transmission grid has a destination. This destination will be the distribution grid or in some cases a high voltage customer.

When the power is not intended for a customer in the transmission grid it will be fed into the distribution grid. The distribution grid is operated at a lower voltage and therefore the electricity has to pass a transformer station which lowers the voltage to the level of the distribution grid. When the power passes through the transformation station it can be considered as 'bought' by the distributed system operator. The DSO operates the distribution grid and is also Program Responsible for this grid. The main purpose of a distributed system operator is to transport the demanded energy to the consumers. These consumers can be connected directly to the distribution grid or to the low voltage grid. In both cases the power will pass several transformers decreasing the voltage. When the electricity is fed into the low voltage grid, the three phase power is split into one phase power tap lines. These tap lines will eventually lead the electricity to a home and eventually into the microwave.

The distribution of electricity is done through several grids. The transmission grid operates at high voltage and transmits the power over great distances. The distribution grid distributes the power on a lower voltage to customers and low voltage grids. Mid voltage connections to the distribution grid have the possibility to produce and consume as a distributed generator, and the behavior of these generators can change rapidly over time. In the high voltage grid, only the net power from a region is regarded at a connection and this will not change rapidly. In the low voltage grid rapid changes are seen, but the power flowing through the grid is a lot lower than in the other two grids. The high amount of fluctuations combined with the reasonably high amount of power in the distribution grid makes it a complex part of the power grid to operate.

2.3 Future of the Power Grid

The Office of Electricity Delivery and Energy Reliability of the U.S. stated the following vision on the power grid on their website [5]:

"A seamless, cost-effective electricity system, from generation to end-use, capable of meeting all clean energy demands and capacity requirements, with: significant scale-up of clean energy

(renewables, natural gas, nuclear, clean fossil), universal access to consumer participation and choice (including distributed generation, demand-side management, electrification of transportation, and energy efficiency), holistically designed solutions (including regional diversity, AC-DC transmission and distribution solutions, microgrids, energy storage, and centralized-decentralized control), two-way flows of energy and information, reliability, security (cyber and physical), and resiliency.”

We will use this vision to briefly discuss the future of the power grid. The goal of TenneT is stated in the first sentence, with the difference that it is explicitly stated that the grid should meet all clean energy demands. An emphasize is placed on the integration of clean energy and this is seen as the biggest future change in the power grid. In the next part of the vision several key points are summed up.

Clean energy In today’s grid we already see a significant amount of clean energy production. For instance in Germany where in view of ”die Energiewende” a lot is invested in clean energy. The goals of this scale up is to reduce our dependence on fossil fuels and decrease the environmental burden of our energy production. We can expect a significant scale up of clean energy in the near future.

Customer participation Nowadays energy does not have to be produced in large power plants. Customers can also participate by placing small generators. This introduces the concept of distributed generation and creates several challenges in the power grid. Customers can also participate in communication with the power grid operators to increase the efficiency of the grid. Another future impact of customer participation is the increase of electric transportation devices. Electric vehicles impose more demands on the grid. However they can also be used as storage devices which is beneficial for balancing the grid.

Solutions The increase of clean energy and customer participation create new possibilities and challenges. In the future we will need solutions designed specifically for these changes. A few possible solutions we want to highlight are microgrids², energy storage and demand response methods³.

Two way flows The increase of distributed generation means that it is possible to create two way power flows. The direction of these power flows can also change over time as distributed generated power fluctuates fast. The increase of customer participation will also impose two way information flows. Information flows are new in the power grid and requires a completely new infrastructure.

Reliability, security and resiliency When the power grid changes the operator also has to change how the grid is operated. The increase of clean energy and distributed generation may impose problems on the reliability and resiliency of the power grid. When the operator exchanges information with customers and introduces more participation new challenges on cybersecurity arise. And so several challenges for maintaining the level of reliability, security and resiliency are to be expected.

²A microgrid is a localized grouping of electricity generation, energy storage, and loads that normally operates connected to a traditional centralized grid

³Demand response: ”Changes in electric usage by end-use customers from their normal consumption patterns in response to changes in the price of electricity over time, or to incentive payments designed to induce lower electricity use at times of high wholesale market prices or when system reliability is jeopardized.” [6]

Chapter 3

Operating the distribution grid

3.1 Westland Infra

In the previous chapter we discussed the power grid infrastructure. We continue with considering the distribution grid on a more practical basis by means of the grid operated by Westland Infra. Westland Infra is the distribution system operator in the region Westland in The Netherlands. Westland Infra is a so called duo-gridoperator, which means that they manage both the electric grid and the gas grid in the area of coverage. The area of coverage of Westland Infra is shown in Figure 3. This area is characterized

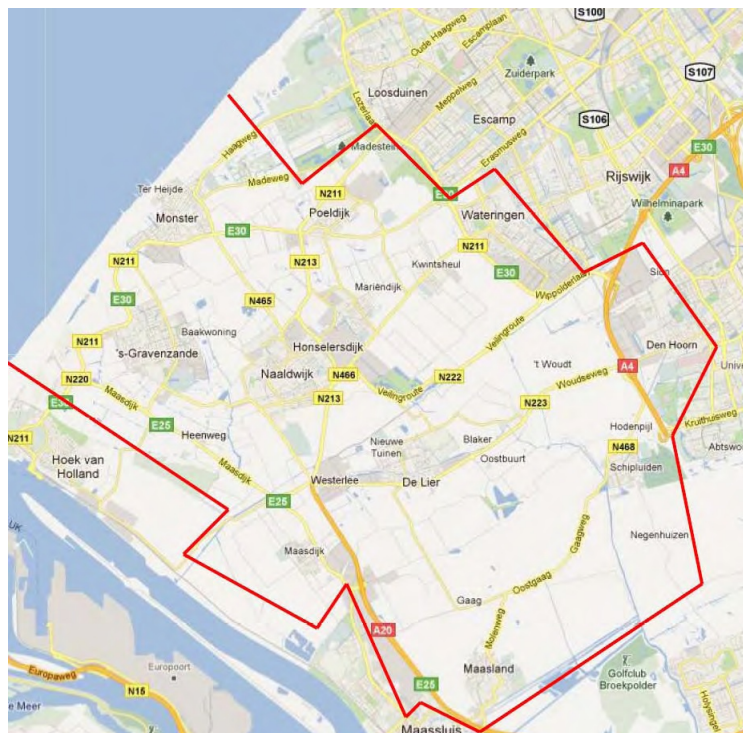

Figure 3: Area of coverage of Westland Infra. To the south lies the harbor of Rotterdam and to the north the area lies adjacent to The Hague. The figure is obtained from [7].

by a large concentration of horticulture which has led to a high population of combined heat and power (CHP) engines. These engines are used in the horticulture because they use gas to produce heat and CO₂ for the green houses. As an additional product a CHP engine also produces electricity. In general, this electricity production is three times the normal power consumption of the greenhouse and is fed back

into the grid. The greenhouse does not need a continuous supply of heat and CO₂, therefore the owner of the greenhouse can freely choose when to use the CHP. To maximize the profit from the produced electricity most CHP engines are used when the price of electricity is high, during peak hours. We can see both properties of the production by CHP engines in the daily load profile of Westland Infra as shown in Figure 4.

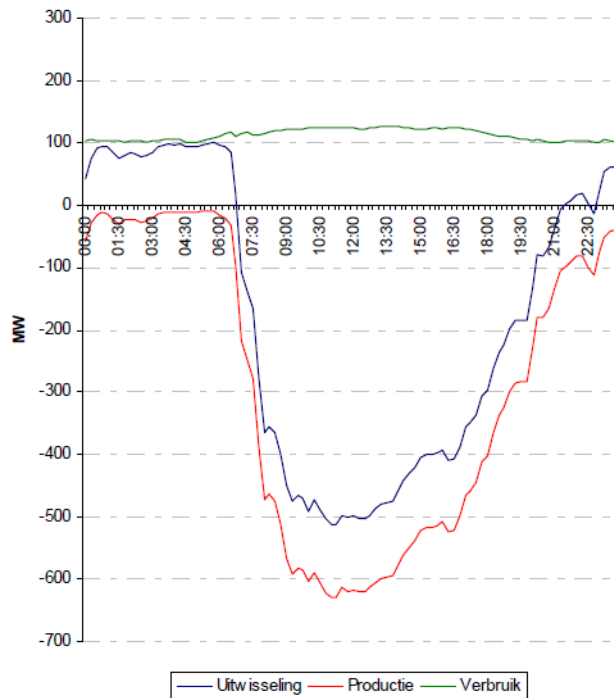

Figure 4: The load profile of the distribution grid of Westland Infra at 2 June 2011. The green line is the consumption and the red line the production. Both lines represent power flowing from the transmission grid into the distribution grid, hence the production is negative. The blue line is the exchange between the transmission grid and the distribution grid, which can be acquired from adding the production and consumption. The figure is obtained from [7].

3.1.1 Distribution grid of the future

We consider the grid of Westland Infra because in this grid we see future challenges already emerging. We discussed that increasing clean energy and distributed generation is a future scenario of the power grid. However Westland Infra already had to deal with a large amount of distributed generation due to the CHP concentration in the grid. Westland Infra had to deal with future problems before anyone else in The Netherlands. In the process of improving the grid decisions occurred which were either technologically or economically argued. In this thesis we seek to take decisions using both technical and economical considerations.

In this chapter we will show the economical and technical effects of overloading the components of the cable system. First we will give a general view of the distribution system operator. Then we will look at the effects of distributed generation in the grid of Westland Infra. This is followed by a closer look on the infrastructure of the distribution grid. Lastly we will look how distributed system operators and Westland Infra in particular make maintenance decisions.

3.2 The Distribution System Operator

The distributed system operator (DSO), in our specific case Westland Infra, manages the distribution grid. The DSO is responsible for the construction, maintenance and management of the distribution grid. The distributed system operator also makes connections for third parties to the grid. If needed, the operator has to make adjustments to the grid such that the desired connection can be made. The distributed system operators have set goals (e.g. the amount of downtime and voltage fluctuations in the distribution grid) and they will act following these goals. It is the decision of the operator which adjustments are made. These decisions depend on the goals that the DSO values.

In the Quality and Capacity documents of several DSO's (Westland Infra [7], Enexis[8], Liander [9]) the goals and visions of the grid operators are listed. Examples of goals are quick, innovative and reliable delivery of services and financial growth for stakeholders. The DSO is an utility and therefore we should note that not making any profit can be a goal. Lately facilitating the increase of clean energy has also been made a goal by the DSO's. The maintenance strategy of the DSO is mostly determined by risk management. The parameters used in determining the risk of an event is the likeliness that the event will occur and the severity of the event, which is shown using a Riskmatrix (Figure 5). The severity of the consequences is determined using different parameters. The most important of these parameters are the safety and reliability of the grid, the costs that the event will induce and the impact on the reputation that an event will have.

		Potential chance on incident						
		unlikely >0.0001/jr	possible >0.001/jr	probably >0.01/jr	regularly >0,1/jr	yearly >1/jr	monthly >10/jr	permanent >100/jr
		1	2	4	8	16	32	64
consequences	score							
Catastrophic	32	M	M	H	H	H	H	H
Severe	16	L	M	M	H	H	H	H
Fairly	8	L	L	M	M	H	H	H
Moderate	4	L	L	L	M	M	H	H
Small	2	L	L	L	L	M	M	H
Neglectable	1	L	L	L	L	L	M	M

Figure 5: Riskmatrix used by several operators to classify events and to determine which actions will be made. The chance of an incident is evaluated with the consequence of an incident. The outcome is the risk of the incident which is classified as Low (L), Medium (M) or High (H). This figure is based on the riskmatrix of Westland Infra in [7].

One of the values that are present in risk assessment is the cost of an incident. In general decision making not only the costs of an incident are considered, but all costs that the DSO makes. We have to distinguish two different expenses, operating expenses (OPEX) and capital expenses (CAPEX). The OPEX are the ongoing cost for the running of a project, business or a system. Under OPEX fall for instance, maintenance and repair, supplies, office expenses and property management. The counterpart of the OPEX are the CAPEX. Capital expenses are the costs of developing or providing non-consumable parts for the product or system. This means that investing in new cables are CAPEX, but the maintenance of these cables are OPEX. Businesses state yearly how much they want to spend on OPEX

and CAPEX and this will also limit the framework in which economists have to work. The OPEX and CAPEX budgets are not only upper bounds, in a utility they can also cause lower bounds on the expenses that are made. A lower bound for the CAPEX costs can be that a DSO has to invest yearly in expanding the cable system. The economists are bound in the expenses they make and also how they distribute these expenses. The goal of an economist however is to maximize the profit made. Maximizing the profit while keeping the costs within the budget is a complex problem which requires a lot of knowledge of the distribution grid. However this knowledge is not always present and most of the time the economical considerations are made by only considering the bounds of OPEX and CAPEX.

We can also consider the return on investment (ROI) as an economical parameter at the DSO. With return on investment we mean the concept of an investment that yields a benefit to the investor. A high ROI means the investment gains outweigh the investment cost. In economics ROI is used to evaluate the efficiency of an investment or to compare the efficiency of a number of different investments. We will mainly consider the return on investment time, as the time at which the gains of an investment outweigh the investment costs.

The technical information of the distribution grid is available at the DSO using a supervisory control and data acquisition system (SCADA). The SCADA system is a computer controlled system that monitors effects in the physical grid using data acquired from sensors at substations. This data is communicated to the central system and presented to the operator. Depending on this information, the operator can decide to take actions, or the data will trigger predefined actions from the system. The predefined actions will be sent to the central system and communicated to remote terminal units and programmable logic controllers who will perform the required action. When we look at the SCADA system used in the distribution grid we should start with the measurements that are made by the system. In the distribution grid the sensors measure voltage and current at substations. In fact, any measuring device can be placed at substations and connected to the SCADA system, but the placement of additional sensors is rare. The measurements can be used for several purposes, for instance state estimation. In state estimation the measurements are used to estimate voltages and power flows at points in the grid where no sensors are present. This estimation can be used to perform contingency analysis. Contingency analysis simulates the behavior of the grid when a component fails in order to determine if the system can still function reliably if such a failure occurs. Besides analyzing what happens if a failure occurs, the SCADA system also notices if a failure occurs in the grid and will notify the DSO if such a failure occurs.

The DSO is a utility and therefore an extensive regulatory framework exists to determine how the grid should be operated. This framework is established in the Elektriciteitswet 1998 and instructions for operating the grid are described in the Netcode [10]. In the Elektriciteitswet it is described that the government gathers, analyses and processes information and data on the certainty of power supply, and especially on the measures taken for future development of the power demand. For the transport of electricity a DSO has legally appointed tasks that ensure that the grid is operating and will be operating during certain contingencies. The grid operator is obligated to honor every request for a connection to the grid and the connection should generally be made within 18 weeks. The tariff for making a connection to the grid may only account for breaking the grid to make a physical connection to the installation of the customer, installing facilities to secure the grid at the new connection and the construction and maintenance of a connection between the break in the grid and consumer. The tariff for transport will only depend on the received energy by the customer and not on the placement of the connection or the generated power.

We can conclude that several different processes take place at a DSO leading to the strategy in managing the distribution grid. Economic goals are bound within the framework of OPEX and CAPEX, while the technical information of the grid is dependent on the extensiveness of the SCADA system. Also every action that the grid operator takes must be according to the regulatory framework and it is possible that the operator is legally obligated to make adjustments in the grid. The effect of these possibly conflicting processes is that in decision making a decision is not always made with the complete knowledge of the technical impact on the grid. In general, the effects of neglecting the technical impact has a small impact on the DSO. This is because of the current structure of the distribution grid. The power is transported from a large source to small sinks. Due to this structure 'rules of thumb' are a good approximation of the actual reality within the grid, it is an 'easy' structure. However with the upcoming

of distributed generation and 'smart grids' the structure of the distribution grid is changing.

3.3 Distributed Generation

In Chapter 2 we have seen that the distribution grid is usually a top down grid receiving power from centralized producers through the transmission grid and distributing it to consumers. However, in the grid of Westland Infra both consumers and distributed generators are represented throughout the grid. To understand the difference between these situations, we should consider the difference between centralized producers and distributed generators. A centralized producer generates a lot of electricity and the amount of electricity produced changes slowly. The centralized producers mostly gain energy from burning gas or coal. The goal of a centralized producer is to meet the demands in the grid at low costs. The distributed generators however are characterized by being able to produce and consume, having a low production compared to centralized producers, being able to change the generation rate rapidly and having large fluctuations in the generation profile. Distributed generators have a high impact on the distribution grid, because they feed their produced energy into lower parts of the grid. The distributed generators are the main source for balancing the grid (e.g. congestion management) because they can alter their production rapidly. The goal of a distributed generator is to make a profit. This has advantages and disadvantages. An advantage is that we can predict and adjust what a distributed producer generates by means of the price of electricity. The disadvantage is that the state and quality of the grid are of no relevance to the distributed producer, he will sell the amount of energy that ensures the highest profit regardless of the technical effects on the grid. The most important differences between centralized production and distributed generation are listed in Table 3.1.

Table 3.1: Difference between centralized producers and distributed generators

Centralized Producer	Distributed Generator
High power generation	Low power generation
Connected to the high voltage grid	Connected to the low/mid voltage grid
Inflexible	Flexible
Meet the demands at low cost	Sell electricity at high profit

What remains is to ask ourselves if we prefer distributed generation over centralized production. This question has been asked before and there exist several studies on the impact of distributed generation. Distributed generators have some influence on the power quality, which is determined by several parameters. The interested reader can consider an article by Passey et al. [11] regarding the technical and non-technical impact of distributed generation. In this thesis we will consider the effects of distributed generation on the infrastructure of the grid. Using predictions for future load profiles, depending on different innovations in generation methods, M. Grond [12] showed that in the distribution grid of Enexis, transmission and distribution cables would be overloaded in certain future scenarios with increased distributed generation. As we have argued before, the current distribution grid is not constructed for the widespread use of distributed generation. This can also be seen from several existing investigations on how to deal topologically with distributed generation in the grid. These investigations consider the placement of distributed generators ([13],[14]) and the topology of the grid as a whole [15]. Other methods to deal with distributed generation that were investigated are congestion management and demand response methods. These methods alter the load distribution of distributed generators and consumers by means of a pricing mechanism in order to optimize the use of the power grid ([16],[17],[18],[19],[20]). Distributed generation, congestion management and demand response are all subjects in developing the 'smart grid'. A literature survey on smart grids can be found in Cardenas et al. [21].

When we consider our practical case at Westland Infra, we see that they had to deal with a large increase in available production power during the period 2005-2009 as shown in Table 3.2. In this table we see that the available production power increased from 190 to 690 MW in this period. The maximum consumption in that period was approximately 270 MW. This means that the peak load in the grid doubled over the course of 3 years. The increase of peak load has led to several capacity problems in the

grid of Westland Infra. The peak exchange between TenneT and the grid of Westland Infra increased from approximately 300 MW to 550 MW. The infrastructure to transform that amount of power to 20 kV was not available and a new transformer station had to be constructed. The high voltage (HV) and middle voltage (MV) transformers to the transmission grid functioned as a bottleneck for the amount of power that could be transported, though the grid infrastructure itself also suffered from the increase in peak load. The capacity problem also occurred on a deeper level in the grid. Generally a greenhouse owner placed multiple CHP engines and therefore increased its local peak load to approximately 7 MW. To transport this amount of power within operating limits cables with a diameter of several decimeters are needed. The needed cable infrastructure was not available and it was not always found possible or beneficial to add new cables. The result of this policy was that at peak load these cables were run at 120% of their intended capacity which has several technical and economical consequences. In a pulse survey of DNV KEMA [22] the utility sector listed increased interconnection of distributed generation as the most significant challenge over the next 5 years. Westland Infra already had to deal with this challenge.

Table 3.2: Available production power in the grid of Westland Infra (Data based on [7])

Year	Available Power (MW)
2003	120
2005	190
2007	420
2009	690
2011	750

3.4 Underground chaos

We have globally discussed the power grid and the distribution of power. The world of a DSO however is different from the theoretical view we have presented. In order to understand the overloading of cables we will discuss the underground infrastructure which is called the distribution grid. First of all we should note that not only power cables run underground. We have constructed an extensive infrastructure below the surface such as, gas pipes, internet cables and waterworks. The underground chaos in a city center is shown in Figure 6. The ground is filled with our infrastructure and space is getting more and more limited. It also means that maintenance to cables is a great task and should be coordinated with other utilities.

The infrastructure needed for an electrical grid imposes its own chaos. In the distribution grid we find substations, connectors, transformers, switchgears, cables and joints. Substations are used for several purposes. They provide space for other components such as transformers or switchgears and are mostly placed above ground. Connectors are used to connect the power cables to other components in substations or at the customers. Transformers are placed in substations to transform the voltage in the grid. A switchgear is a mechanical component used to guide the electricity to certain cables. Switchgears are used at intersections in the grid. In this thesis we will focus on the performance of cables and joints. In the next part we will give a detailed explanation of these components and we will discuss the effects of overloading.

3.4.1 Cables and joints

We stated that the overloading of cable components have technical and economical consequences. In this section we will show that these consequences are not only present when the cables are run above capacity but also when the grid is operated within the stated limits. The components of the cable system under consideration are cable joints and the cables themselves. Cables are made of a conducting material in order to transport electricity. In the distribution grid, cables are mostly placed underground. Therefore it is necessary to provide insulation around the conductor to prevent electrical short circuits.



Figure 6: Picture of underground infrastructure in a city center.

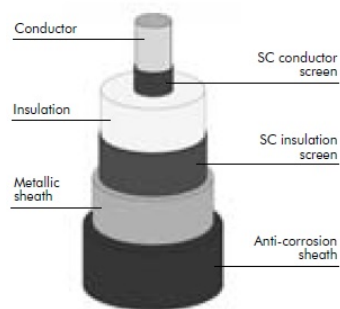

Figure 7: Inside of a single conductor cable. Figure obtained from [23].

Figure 7 shows the inside of a middle voltage cable. In the center of the cable we can see the conductor, which in practice is made from copper or aluminium. The electrical resistance of copper is lower than the resistance of aluminium and copper is less susceptible for corrosion. Aluminium however is far lighter than copper and enables longer cables lengths. This means less joints. The price of aluminium is also lower, making it a more economical choice than copper. Aluminium conductors are usually used in distribution networks requiring long distances and a large amount of cabling. Copper cables are used for short links in stations or industrial installations.

The conductor screen consists of a layer of semi-conductive compound, this layer is generally less than 1 mm thick. This screen is used because the edge of the conductor may not always be smooth. The conductor screen is a smooth surface at the same potential to keep the electric field consistent all the way around the surface and therefore it protects the insulation from high spikes in electrical energy. After the conductor screen a thick layer of insulation follows. As noted, this layer is necessary to prevent electrical short circuits. Nowadays the common material for middle voltage cable insulation is cross linked polyethylene (XLPE). The insulation screen is placed around the insulation. This screen has the same function as the conductor screen. It is a semi conducting layer in order to provide a smooth transition from the insulation to the grounded metallic sheath. This metallic sheath is placed around the cable to diminish the electric field outside of the cable. The screen has to be connected to the electrical earth and therefore it also drains the short circuit current when a failure occurs in the cable. Lastly the cable is placed in a anti-corrosion sheath which insulates the metallic sheath from the ground, protects

metal components from corrosion and protects the cable from mechanical stresses. As we have noted in our discussion on the conductor material, there are practical and economical reasons for the maximum length of a piece of cable. In the distribution grid of Westland Infra this length is 400 meters on average. The cables used are XLPE insulated aluminium cables.

In general the length of a transmission line is more than the length of a cable section and these sections have to be connected to each other. The sections in a transmission line are connected using cable joints. There exist several types of joints depending on the method used to connect the cable sections and the insulation of the joint. We consider two connection methods. The common method to connect the cable sections is to press them together in the joint. The connector in the center of the joint consists of a large smooth conduction area, through which the electricity is transported. The other method is to use a carved conducting area in the connector that is screwed tightly on the cable. We will call these joints respectively compressed joints and screwed joints. The connectors used in these joints are shown in Figure 8. At Westland Infra the majority of the cable joints are press joints. We should note however that Westland Infra is changing the population joints from compressed joints to screwed joints.

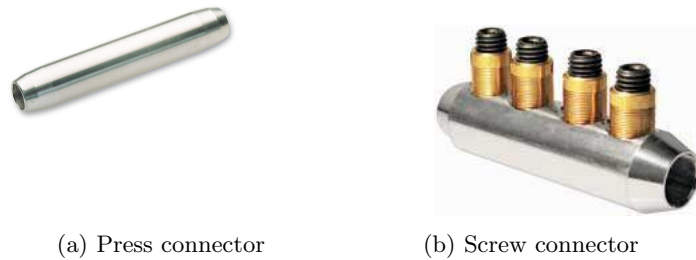

Figure 8: Cable connectors used in compressed (a) and screwed (b) joints.

Joints can also be classified by means of the insulation type. There are two main classes of insulations: filled and mass insulation. Both types use some insulation material to insulate the cable conductors from the joint casing. In mass insulated joints this insulation is always solid, while the insulation in filled joints can have fluid properties. The insulation materials used in filled joints are for instance oil, silicon gel or resin. In this thesis we consider mass insulated joints using XLPE as insulation material. An example of a mass insulated compressed joint is given in Figure 9. In order to connect the

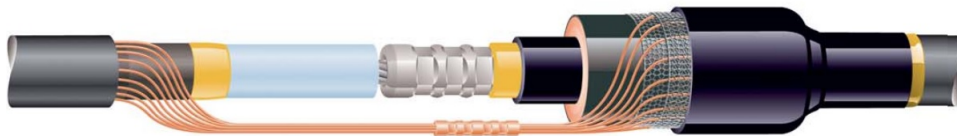

Figure 9: Mass insulated compressed joint. Figure obtained from [24].

cables to each other, the insulation layers of the cables have to be stripped inside the joint. Therefore we see that the shielding of the joint consists of a conductor screen, an insulation screen, a metallic sheath and an outer sheath just as seen for cables. In the center of the joint the stripped cable conductors are joined in the connector. As we can see from Figure 8 the area of conduction in a connector is generally larger than in the cable itself. However due to thermal and mechanical stresses the cable conductors can move within the connector and therefore it uses a smaller area of conduction. Due to this movement the cable conductor will also rust, especially when the conductor is aluminium. This decreases the area of conduction even further meaning that the joint can have a higher resistance than the cable.

3.5 Overloading of cables: introduction and consequences

We have to develop a notion of the capacity of a cable in order to proceed to the effects of overloading in the cable system. Cable manufacturers provide an ampacity for the cables. The ampacity is the maximum continuous current that is allowed to flow through the cable. It is also possible that the manufacturer provides a temperature bound on the cable. This bound is determined by the thermal degradation of the insulation. For XLPE insulated cables the maximum rated temperatures are given in Table 3.3.

There are two processes working in the thermal degradation of XLPE insulation. When the temperature of the insulation is above 130 degrees Celsius the insulation will melt and deform. If the insulation melts, the conductor will have the possibility to connect to the earth and induce a short circuit. When the temperature is only high for a short period of time the insulation will deform making the cable more vulnerable to failures. The second process is the thermal oxidative degradation. An anti-oxidant

Table 3.3: Maximum rated temperatures of XLPE insulated cables

Conditions	Maximal Temperature
Normal operating conditions	90°C
Emergency operating conditions (< 300 hours)	105° C
Short-circuit (< 5 sec)	250° C

is present in the insulation to prevent it from oxidating. Anti-oxidants have a certain chemical lifetime which is shorter at a higher temperature. This is because the reaction which uses the anti-oxidant will go faster if the temperature is higher. Therefore also under 130 degrees the cable will degrade faster if the temperature is higher than the normal operating conditions (90°C). We should note that this consideration works both ways, so a cable operated at low temperatures will have a longer lifetime.

In general the DSO does not know the temperature of the cables in the grid. Therefore the ampacity is used as a guideline for the capacity of the cable. The ampacity is derived from the bounds on the temperature, using the temperature development in the cable under a constant current. The temperature development in a distribution cable is a complex process. It depends on all the different layers of the cable, the specifications of the conductor and the placement in the soil. The ampacity I^* of a cable can be calculated using the Neher-McGrath equation [25]

$$I^* = \sqrt{\frac{T_c - (T_o + \Delta T_d)}{R_{ac}\bar{R}'_{ca}}}, \quad (3.1)$$

where T_c is the maximum conductor temperature, T_o is the temperature of the earth outside the cable and ΔT_d is the temperature rise resulting from dielectric losses. The temperature increase by dielectric losses are caused by dissipating the electromagnetic energy formed by the conductor into heat. The term $R_{ac}(1 + Y_c)$ is the effective electrical resistance with R_{ac} the alternating current resistance of the conductor. Lastly we have the term \bar{R}'_{ca} which represents the effective thermal resistance of the thermal circuit in the cable. This elaborate equation calculates the maximal continuous current the cable can handle when we know the maximum temperature. We can invert the Neher-McGrath equation to see what happens if we run a general continuous current I through the cable. Then we get the equilibrium temperature T of the conductor as

$$T = I^2(R_{ac}\bar{R}'_{ca}) + T_o + \Delta T_d. \quad (3.2)$$

We can deduce from this equation that the temperature increases quadratically with the current and linearly with both the electric and thermal resistances.

The energy to heat up the cable comes from the transported power. The power used for heating the cables is lost, it is supplied by the producer but can not be consumed. When these losses occur in the distribution grid, they are completely for the DSO. The DSO's have knowledge on the total transportation losses that occur in the distribution grid. The total transportation losses in 2011 for Westland Infra and

	Westland	NLs gemiddelde
Getransporteerde elektriciteit [GWh]	2.595	94.373
Netverliezen [%]	2,7%	4,7%

Figure 10: The total transported energy in GWh and the percentual transportation losses in the grid of Westland Infra and the total for all DSO's in The Netherlands. Figure obtained from [26]

for all DSO's in The Netherlands combined are shown in Figure 10. An investigation by KEMA on the distribution of the costs of transportation losses [27] found that 70% of the losses are technical and 30% are administrative losses. We can then calculate that Westland Infra had technical transportation losses of 49 GWh in 2011, which accounts for approximately 3 million euro. The technical transportation losses in the distribution grid are linearly related to the electrical resistance and quadratically to the current. This also means that overloading the cable will increase the costs related to the transportation losses quadratically.

3.6 Maintenance in the distribution grid

We noted in Chapter 2 that the DSO uses a SCADA system to monitor the distribution grid. A function of the SCADA system is to perform reliability analysis on the grid. Reliability analysis is performed to predict when limits in the grid are exceeded and to act such that the consumer has the least downtime possible. These limits are mostly an upper bound on the current in a single cable.

When we consider the reliability of cables, we see that most of the failures in the distribution grid are due to the failure of joints and cables. This is also seen from the failures that occurred in the distribution grid of Enexis in the period 2006-2010 as shown in Figure 11. In the previous section we discussed that

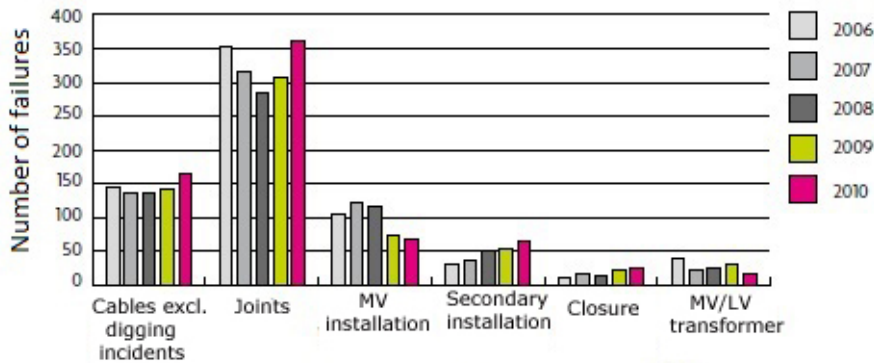

Figure 11: The yearly number of failures in the grid of Enexis for different components in the period 2006-2010. The figure is based on [8].

internal failures are caused by the thermal degradation of the insulation and that this happens more often in joints because of a possibly higher resistance. The internal failures of cables and joints are monitored by using partial discharge methods, which can be done online or offline. Partial discharge methods show dielectric effects in the insulation, which can relate to deformations of the insulation. These discharges occur because of an enhanced electric field in the insulation which is generated due to cavities within the insulation. The increase of partial discharges is an indication for a possible melting cable. This method can be considered as reactive maintenance. With reactive maintenance we mean

that a predefined limit is exceeded or a failure occurred before the DSO takes action. Partial discharges theoretically detects a problem before failure. Though when the insulation is melting the increase in discharges is only noticeable when the insulation has almost completely melted and will induce an outage. Partial discharges is a good method to detect deformations in the cable, but it still is a reactive method.

Westland Infra had to deal with the overloading of the cable system in combination with the corrosion of joints. Therefore they were confronted with melting joints and the limitations to detect this with reactive methods. In order to notice possible failures due to melting sooner the use of temperature measurements has been employed at weak spots of cables, which in the case of Westland Infra are mostly joints. Sensors have been placed on the insulation of the joints and measure the temperature of the insulation. Temperature measurements can be used to check whether the insulation is melting but it provides more information. The corrosion of joints can be seen from an increase in the equilibrium temperature. If the normal operating temperature for cables is violated it is possible to keep track of faster degrading cables. This method does not consider the predefined limits on the current but a new limit defined due to the technical problems in a joint. We will call this kind of maintenance method a proactive method.

Chapter 4

Modeling the distribution grid

In the previous chapter we have discussed how the power grid functions and which practical issues exist in the distribution grid. In this chapter we will discuss how we make the transition from the real world to a mathematical model. A mathematical model of a system is a description of how the system functions in real life. When modeling one should always note that we make an approximation of the real world. During the course of this chapter we will show which assumptions were made and we will discuss the accuracy of the model.

In this chapter we will start by showing how we translate the structure of the distribution grid to a mathematical object. Then we will show which components are considered and how we model these, followed by the method we use to compute the power flow in the system. Finally we will describe some particular characteristics of the model such as the costs that we take into account and how maintenance in the grid is treated.

4.1 Components and their mathematical representation

The distribution grid is a complex network which consists of many different components. Modeling all of these components is an extensive task, and is already done by different developers of power system software. For the sake of this investigation we will consider a part of the distribution grid that only consists of substations, generators, consumers and producers which are connected through cables. These cables can be divided into smaller cable parts connected by joints. This kind of structure, points connected by links, can be represented mathematically by using an undirected graph G^1 . The graph consists of a set V , containing the points or nodes, and a set E , which contains the lines or edges connecting the nodes. In this representation the substations, consumers and producers are all modeled as nodes in the set V and the cable system is represented by edges in the set E . In Figure 12 we have shown the representation of an outer segment of the distribution grid.

We need to specify certain characteristics for the components in our grid besides the classification into nodes and edges. We start with the substations. Substations can be treated in different ways. If we consider the entire distribution grid they can be modeled as nodes without any energy demand. In a smaller system as given in Figure 12 they can be modeled as slack nodes. When a node is considered a slack node it consumes all left over energy in the system considered, which can be both positive and negative, to balance the power flow in the system. We will not consider the failing of mechanical parts of the grid, such as substations, as we are interested in the effects of temperature developments in the grid.

Customers are the reason why the power grid exists and the behavior of these customers has a large impact on the grid. We consider two different customer connections to the distribution grid, a consumer

¹A graph is set of nodes represented by V and a set of edges of pairs of nodes represented as E . A graph can be represented graphically with the nodes as dots and the edges as lines connecting the dots. In an undirected graph the edges have no orientation.

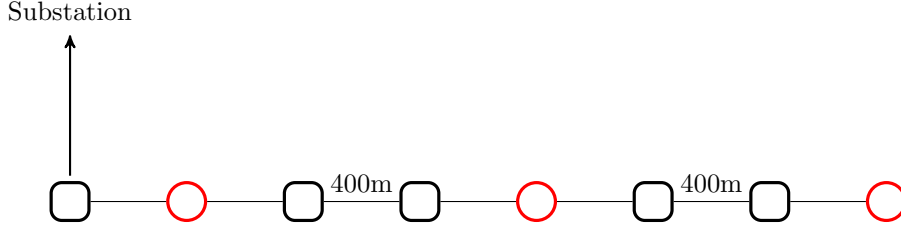

Figure 12: Representation of an outer branch of the distribution grid with the characteristic length between joints. The red circles are connections to lower parts of the grid or customers. The black rectangles represent the cable joints. The cable joints are modeled as part of the edges.

connection and a prosumer connection. The difference between these two is that a consumer connection will only demand energy and a prosumer connection can consume and produce energy. As shown in Chapter 2, in an AC power grid we have to consider the power factor in the grid. In general we do not know what happens when the power leaves the distribution grid. Therefore we also have no notion on the power factor of the connections. In this model we assume the power factor at all connections as

$$\cos \varphi = 0.9. \quad (4.1)$$

This assumption is based on the idea that almost every consumer needs a transformer to lower the voltage of the power. The power factor we use is the power factor of a transformer. We assume that this is the only interaction of the grid with external electromagnetic devices.

We have described the components in the grid that are represented by nodes. The entire structure of the power grid is determined by the connections between these components, the cable system. We describe a distribution grid with three phase power, therefore the number of cables in a line has to be a multiple of three. Every edge is split into several shorter cable sections separated by joints. Every edge has a total length which can be translated into an amount of sections on the edge. At Westland Infra the average length of these sections is 400 meters. We assume that the length of the length of the entire cable. In the model edge (i, j) of length l_{ij} will have $s_{ij} = \lceil \frac{l_{ij}}{400} \rceil$ sections. At such an edge $s_{ij} - 1$ sections are 400 meters long and one cable section has length $l_{ij}^* = l_{ij} - 400(s_{ij} - 1)$. We can also say something about the number of joints on a cable. The number of joints on a cable J_{ij} is given by the number of points where the sections need to be combined which is $J_{ij} = s_{ij} - 1$.

From Chapter 3 we notice that cable joints have a slightly different resistance from the cable itself dependent on the position of the cable in the connector. Due to corrosion of the joint the resistance of the joint can increase. The result of this higher resistance is that the joint heats up faster and thus fails faster. We assume that the initial change in resistance, without corrosion, is negligible as it oscillates around zero in time. This oscillation is caused by the movement of the cable in the connector due to thermal stresses. The increase of the resistance due to corrosion is modeled as a function of the percentage of the cable in the joint that is corroded, given by $c(t) \in [0, 0.9]$,

$$r_{\text{joint}}(c(t)) = \frac{r_{\text{cable}}}{1 - c(t)}. \quad (4.2)$$

We have chosen for a maximum corrosion percentage of 90% to account for the asymptotic nature of a chemical process. The increase in corrosion percentage $dc(t)$ in t years is modeled as a uniform random variable on the interval $[0, 0.05 \cdot t]$. We have modeled $dc(t)$ in this way to ensure that we see significant corrosion within the lifetime of a joint.

4.2 Power Flow Analysis

An important problem in power grid analysis is the evaluation of the power flow equations, which describe how the power will flow through the system under certain loads of the customers. The behavior of electricity in a circuit is governed by the Kirchhoff equations for AC power. From these equations and

the load distributions of the customers the power flow in the grid can be determined. We will follow the derivation of Idema [28] to derive and solve the power flow equations. We have already derived a notion of AC power in Chapter 2. In equation (2.3) we have shown the time dependent behavior of AC power and we defined the real (2.4) and reactive (2.5) power. The equations for voltage (2.1) and current (2.2) leading to this result were derived assuming a steady state. In steady state power flow analysis we can omit the constant frequency ω and use the effective phasor representation for the voltage and current

$$V = |V|e^{\iota\delta_1}, \quad (4.3)$$

$$I = |I|e^{\iota\delta_2}, \quad (4.4)$$

where ι is the imaginary unit. We can see from equations (2.4)-(2.5) that

$$P = \text{Re}(V\bar{I}), \quad (4.5)$$

$$Q = \text{Im}(V\bar{I}), \quad (4.6)$$

where \bar{I} is the complex conjugate of I . The complex power is given by

$$S = P + \iota Q = V\bar{I}, \quad (4.7)$$

where S is measured in Volt-Ampere (VA)².

An important quantity in power flow analysis is the resistance. In order to analyze the resistance of a steady state AC circuit we define the impedance Z as a measure of opposition to a sinusoidal current

$$Z = R + \iota X, \quad (4.8)$$

which is measured in Ohms (Ω). The real part, R , is called the resistance and the imaginary part, X , is called the reactance. We can now also define the admittance

$$Y = G + \iota B, \quad (4.9)$$

as the inverse of the impedance

$$Y = \frac{1}{Z} = \frac{R}{|Z|^2} - \iota \frac{X}{|Z|^2}, \quad (4.10)$$

which is measured in Siemens (S). In this equation the real part, G , is called the conductance and the imaginary part, B , the susceptance. Using this definition of impedance we can find the AC extension of Ohm's law³,

$$V = ZI. \quad (4.11)$$

From this law we can also calculate the power lost due to the impedance of a line, the transportation losses,

$$S_{\text{lost}} = V\bar{I} = |I|^2 Z = |I|^2 R + \iota |I|^2 X. \quad (4.12)$$

Kirchhoff equations Until this point we have developed an extension to steady state AC power circuits for all important quantities in power flow analysis. We continue with evaluating the governing Kirchhoff equations for the voltage and current in electrical circuits. First we have the current law

$$\sum_k I_k = 0, \quad (4.13)$$

which states that at any point in the circuit the sum of currents flowing toward that point is equal to the sum of currents flowing away. The current law gives rise to an equation at every node in the circuit where the sum is taken over the branches connected to this node. The second law is the voltage law which induces an equation for every closed circuit in the system

$$\sum_k V_k = 0, \quad (4.14)$$

where the sum is taken over all nodes in the circuit. The voltage law states that the directed sum of the electrical potential differences around any closed circuit is zero.

²Volt-Ampere is the unit used for the complex power. Volt-Ampere is related to Watt through the power factor.

³Ohm's law, named after Georg Ohm, states that the current through a conductor between two points is directly proportional to the potential difference across the two points. This is stated in the mathematical formulation as $I = \frac{V}{R}$.

4.2.1 One phase power flow model

Knowing the governing equations and important parameters we can continue to the actual power flow in the system. In general, power systems are modeled as a network of buses (connection points between several lines, customers and generators) and branches. At each bus i there are four electrical quantities of importance

- $|V_i|$, the voltage amplitude,
- δ_i , the voltage phase angle,
- P_i , the injected active power and
- Q_i , the injected reactive power.

For each bus two of these magnitudes are specified and the buses are named accordingly, as shown in Table 4.1. We model the substations as slack buses and the connections at load buses.

Table 4.1: Naming of buses

Bus name	Specified	Not specified
Load bus or PQ bus	P_i, Q_i	$ V_i , \theta_i$
slack bus	$\theta_i, V_i $	P_i, Q_i

In the power flow analysis we need to consider the resistance of the branches. We define the impedance z_{ij} for every edge (i, j) . From the impedance we can calculate the admittance of a line $y_{ij} = \frac{1}{z_{ij}}$. We can transform the admittance of the lines to a network quantity by defining the admittance matrix \mathbf{Y} . This matrix relates the injected current at each bus to the bus voltages by using a matrix version of Ohm's law (4.11)

$$\mathbf{I} = \mathbf{Y}\mathbf{V}, \quad (4.15)$$

where \mathbf{I} is the vector of injection currents at each bus and \mathbf{V} the vector of bus voltages. Following the previous considerations we can also define the impedance matrix as $\mathbf{Z} = \mathbf{Y}^{-1}$.

Before we can do a power flow analysis we have to calculate the admittance matrix. For that purpose we define I_{ij} as the current flowing from node i to node j , where $j \neq i$. When we apply Kirchhoff's Current Law we find

$$I_i = \sum_k I_{ik}. \quad (4.16)$$

For a transmission line from i to j we can again apply Ohm's law and find

$$I_{ij} = y_{ij}(V_i - V_j), \quad (4.17)$$

and

$$I_{ij} = -I_{ji}. \quad (4.18)$$

From this equation we can find the total contribution of a line between i and j to the admittance matrix

$$\begin{bmatrix} I_{ij} \\ I_{ji} \end{bmatrix} = y_{ij} \begin{bmatrix} 1 & -1 \\ -1 & 1 \end{bmatrix} \begin{bmatrix} V_i \\ V_j \end{bmatrix} \quad (4.19)$$

When we combine the equations for complex power (4.3)-(4.4) and Ohm's law (4.15) we can find the complex power at each bus

$$S_i = V_i \bar{I}_i = V_i (\bar{\mathbf{Y}} \bar{\mathbf{V}})_i = V_i \sum_{k=1}^N \bar{y}_{ik} \bar{V}_k, \quad (4.20)$$

this equation is valid for a system with $N + 1$ buses, from which one bus is the slack bus. We can write these equations in a different form where we want to find the real power flow through a line

$$P_{ij} = |V_i||V_j|(G_{ij} \cos(\theta_i - \theta_j) + B_{ij} \sin(\theta_i - \theta_j)). \quad (4.21)$$

4.2.2 Three phases power flow model

We have derived a formulation of the power flow problem. In this derivation we assumed a one phase power circuit, by only specifying one P_i and Q_i at every bus. In three phase power flow, every line consist of three cables with a phase difference between the cables. Therefore in three phase power flow analysis one should specify three phase load variables, for instance $P^{(1)}$, $P^{(2)}$ and $P^{(3)}$ as real power variables at each bus. We can however deduce characteristics of the three phase power flow from one phase power flow analysis. In order to do this we first take a deeper look into three phase power flow. There are two different configurations for three phase power flow, the wye and delta configuration. The difference between these configurations is the set up at the start and end of the cables. In the conductors the only difference between the configurations is whether the phase difference is in the voltage (wye) or the current (delta).

We will only consider the wye configuration. A schematic view of the wye configuration is shown in Figure 13. In this configuration all three wires are connected to the same point. The AC power generated

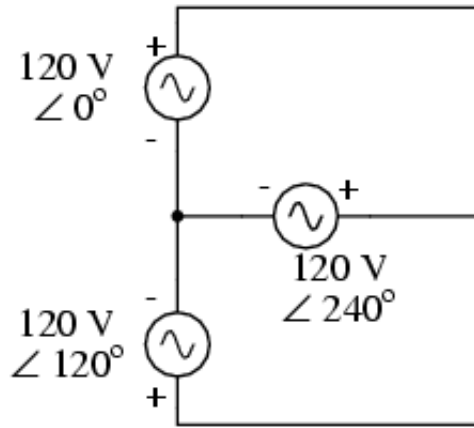

Figure 13: Schematic representation of a three phase wye connection.

is converted into three flows with a phase difference of 120 degrees in the voltage. When the power is consumed or transferred to a one phase line, these three flows are joined back together using the same wye configuration. In three phase power flow we consider line and phase voltages. The line voltage, V_L , is the voltage measured between two conductors of the three phase system. The phase voltage, V_ϕ , is defined as the voltage measured between a conductor and the earth. We can find a relation between the phase and line voltage by adding the periodic voltages of two lines with a phase difference of 120 degrees

$$\sqrt{2}V_\phi(\cos(\omega t + \frac{\pi}{3}) - \cos(\omega t)) = \sqrt{6}V_\phi \cos(\omega t - \frac{\pi}{6}). \quad (4.22)$$

We see that the voltage profile measured between the two conductors is shifted 60 degrees and the amplitude is increased with a factor $\sqrt{3}$. The amplitude of the voltage profile between the conductors is the line voltage. This means that we have a relationship between the line voltage and the phase voltage,

$$V_L = \sqrt{3}V_\phi. \quad (4.23)$$

In this configuration the phase shift is only applied to the voltage. This means that the currents are not shifted and the line current is equal to the phase current,

$$I_L = I_\phi = I. \quad (4.24)$$

We will derive a one phase analogy for the three phase power flow problem using the line voltage. We have not encountered such an analogy in the literature. We can express the power transported over a single conductor in terms of the line voltage,

$$S_{\text{con}} = V_\phi \bar{I} = \frac{V_L \bar{I}}{\sqrt{3}}. \quad (4.25)$$

This equation is valid for each of the conductors and this leads to the total power in the three phase line

$$S = 3S_{\text{con}} = \sqrt{3}V_L\bar{I}. \quad (4.26)$$

We can also transform the matrix version of Ohm's law (4.15) to three phases by substituting (4.23)

$$\mathbf{I} = \frac{1}{\sqrt{3}}\mathbf{Y}\mathbf{V}_L. \quad (4.27)$$

We can use the equations of the power in the three phase system and Ohm's law in three phases to alter equation (4.20) and find the three phase equation for the complex power at bus i

$$S_i = \sqrt{3}V_{L,i}\left(\frac{1}{\sqrt{3}}\bar{\mathbf{Y}}\bar{\mathbf{V}}_L\right)_i = V_{L,i}\sum_{k=1}^N \bar{y}_{ik}\bar{V}_{L,k}. \quad (4.28)$$

We have to solve the same equations as in the one phase case with as difference that we use the line voltage and not the phase voltage.

4.2.3 Solution method

We will continue with the solution method to solve the power flow equations. We will again follow the work of Idema [28]. Before we discuss the solution method used to solve the power flow equations we want to write these equations in an easy vector form. The equation for the real power flow through a line (4.21) is more convenient for use in calculations than the equations for complex power at each bus (4.20) and (4.28). In the following consideration we use the one phase power flow equations, knowing that it is equivalent to the three phase version. We make some substitutions and rewrite equation (4.20) to find

$$S_i = \sum_{k=1}^N |V_i||V_j|(\cos(\delta_{ik}) + \iota \sin(\delta_{ik}))(G_{ik} - \iota B_{ik}). \quad (4.29)$$

In order to find a solution method for this equation we define the state vector

$$\mathbf{x} = [\theta_1, \dots, \theta_N, |V_1|, \dots, |V_N|]^T, \quad (4.30)$$

the voltage angles θ_i are defined such that $\delta_{ij} = \theta_i - \theta_j$. The power flows through each line is given by

$$P_{ij}(\mathbf{x}) = |V_i||V_j|(G_{ij} \cos(\delta_{ij}) + B_{ij} \sin(\delta_{ij})), \quad (4.31)$$

$$Q_{ij}(\mathbf{x}) = |V_i||V_j|(G_{ij} \sin(\delta_{ij}) - B_{ij} \cos(\delta_{ij})), \quad (4.32)$$

which make up matrix functions $\mathbf{P}(\mathbf{x}), \mathbf{Q}(\mathbf{x})$. Note that in AC power flow $P_{ij} \neq P_{ji}$, and the same for Q_{ij} . We also define vector functions $\mathbf{P}(\mathbf{x}), \mathbf{Q}(\mathbf{x})$ for the power at each bus

$$\mathbf{P}_i(\mathbf{x}) = \sum_k P_{ik}(\mathbf{x}), \quad (4.33)$$

$$\mathbf{Q}_i(\mathbf{x}) = \sum_k Q_{ik}(\mathbf{x}). \quad (4.34)$$

Using these definitions we can write (4.29) as

$$\mathbf{S} = \mathbf{P}(\mathbf{x}) + \iota\mathbf{Q}(\mathbf{x}). \quad (4.35)$$

Solving the power flow equations (4.20) is equivalent to solving the matrix equation (4.35) for \mathbf{x} where \mathbf{S} the input power of every bus except the slack bus.

In order to derive an easy to use description of the power flow equations we define the following matrix functions

$$f(\mathbf{x}) = \begin{bmatrix} \mathbf{P}(\mathbf{x}) \\ \mathbf{Q}(\mathbf{x}) \end{bmatrix}, \quad (4.36)$$

$$g(\mathbf{x}) = \begin{bmatrix} P(\mathbf{x}) \\ Q(\mathbf{x}) \end{bmatrix}. \quad (4.37)$$

We also define an input vector of the bus loads

$$\mathbf{W} = \begin{bmatrix} \mathbf{P} \\ \mathbf{Q} \end{bmatrix}, \quad (4.38)$$

$$(4.39)$$

where \mathbf{P} is the real load input vector and \mathbf{Q} the reactive load input vector. In the same spirit we define an output vector of the average power flowing through the lines made up of vectors of the real and reactive power flow on the branches,

$$\mathbf{Z} = \begin{bmatrix} P \\ Q \end{bmatrix}. \quad (4.40)$$

$$(4.41)$$

Now the power flow problem has reduced to finding the solution $\bar{\mathbf{x}}$ of

$$f(\bar{\mathbf{x}}) = \mathbf{W}, \quad (4.42)$$

and computing the power flows at the branches by evaluating

$$\mathbf{Z} = g(\bar{\mathbf{x}}). \quad (4.43)$$

We have derived the power flow problem as the system of equations given by (4.42). This is a non-linear system of equations and for a regular grid this system is also large. Numerical methods have been developed to solve the system of equations, the most common method being the Newton-Raphson method. The nature of the Newton-Raphson method determines that the power flow equations have to be written in the form $F(\mathbf{x}) = f(\mathbf{x}) - \mathbf{W} = 0$, which is called the power mismatch function in power flow analysis. In order to solve the problem we need to invert the Jacobian matrix $J(x)$ which is not necessarily invertible. For a consideration on the speed of the Newton-Raphson method and a Newton-Krylov method one can read [28]. An example of a singular Jacobian and a discussion on the impact of the singularity can be found in [29]. In our investigation, the AC power flow computations are done by MatPower. This is a free to use add-on for Matlab developed by Zimmerman et. al. [30].

4.3 Modeling of failures

We want to quantify failures in the grid. We can do this by developing probability distributions on the failure of components. These failure distributions are developed from known distributions and by using some rules on the behavior of the grid. Anghel et al. [31] used an approach that randomly models the failure of components by using the Poisson process. The Poisson process assumes component failures occur independently of each other and of the past. We use this to model failures due to external processes such as cables hit when digging or by trees. For the number of random failures of component i up to time t the Poisson distribution is given by

$$P_i(N_i(t) = n) = \frac{(\lambda_{fi}t)^n}{n!} e^{-\lambda_{fi}t}, \quad n \geq 0, \quad (4.44)$$

from which we can find the expected value $\mathbb{E}[N_i(t)] = \lambda_{fi}t$. From this expectation value we can see that λ_{fi} is the average number of failures per unit time, which can be seen as a failure density of the component. When we look at random failures we can argue that components that have more interaction with the environment will have a larger failure density. Therefore we will assume that the failure density has a direct relation with the length of the component $\lambda_{fi} = \lambda_f l_i$, where l_i is the length of the component. We assume that in a cable of 1 kilometer the expected number of random failures in 30 years is 0.9. This to ensure that we see some random failures in the lifetime of a cable. This leads to $\lambda_f = \frac{0.9}{30 \cdot 365}$. For joints we need to specify λ_{fi} as we do not consider the length of a joint. We have specified for joint i $\lambda_{fi} = \frac{\lambda_f}{100}$. This assumption is the same as assuming that a joint is approximately 1 meter long. In a

Poisson process the times between two events is given by an exponential distribution. So the time t until the next failure of component i is a random variable with distribution

$$f(t) = \lambda_{fi} e^{-\lambda_{fi} t}. \quad (4.45)$$

The Poisson distribution is constructed for random line failures and does not take the past of a component into account. We can also look at internal failures. Then we actually see that these failures occur because of the past of the component and we also know that the age of a component has an influence on the failure rate. To model the failures of components depending on the age of the component the Weibull distribution is considered as the common distribution ([32],[33]). The Weibull distribution for the chance that a component has a fatal failure at age \bar{a} is given by

$$f(\bar{a}) = \frac{\beta}{\eta} \left(\frac{\bar{a}}{\eta}\right)^{\beta-1} e^{-\left(\frac{\bar{a}}{\eta}\right)^\beta}. \quad (4.46)$$

In this equation β is a shape parameter and η is a scale parameter. The expected age of failure is given by $\mathbb{E}(a_f) = \eta \Gamma(1 + \frac{1}{\beta})$, with $\Gamma(z) = \int_0^\infty t^{z-1} e^{-t} dt$. To estimate the scale and shape parameters we use an investigation on the statistical life data of joints by Mehairjan [33]. In this investigation it was concluded that for mass insulated joints the Weibull distribution was the best considered fit with $\beta = 4.93$. We assume that this scale parameter is a good estimation for joints and cables. We also assume that the expected thermal age of all components is 30 years and then we can solve equation (4.47) for η , which leads to $\eta = 32.7$.

$$30 = \mathbb{E}(a_f) = \eta \Gamma(1 + \frac{1}{4.93}). \quad (4.47)$$

4.3.1 Temperature equations and overheating

The most occurring outages in an overloaded grid are related to the temperature of the conductor. When the temperature is too high, we can have a failure because of thermal aging or a direct failure. Thermal aging failures are caused by the degradation of the insulation of components. To be able to model both processes we first model the temperature development in a cable.

We consider the problem of conduction of heat in a thin rod that is subjected to a constant current. We will use the derivation of by Carslaw and Jaeger [34]. We assume the rod is so thin that the temperature is the same at all points in the cross-section. In the following consideration A is the area of the wire, O the perimeter of the wire, H the surface conductance to the earth, R the electrical resistance of the wire, ρ the density and c the specific heat of the wire. In this derivation we assume that the heat flux from a line with temperature T to the surroundings of temperature T_o is linear in the temperature difference and is given by $H(T - T_o)$. We also assume that power flow fluctuations propagate a lot faster than heat fluctuations. This last assumption combined with the notion that the heat sources are equally distributed through the rod assures that we can use $T(x, t) = T(t)$. This leads to the following equation for the temperature in the rod

$$\frac{\partial T}{\partial t} = \frac{|I|^2 R}{\rho c A} - \nu(T(t) - T_o), \quad (4.48)$$

in which $\nu = \frac{HO}{\rho c A}$ and $|I| = \frac{P}{|V| \cos(\varphi)}$ is the electrical current through the rod. When we assume initial temperature $T(0)$ we can obtain the solution

$$T(t) = e^{-\nu t} (T(0) - T_e(P)) + T_e(P), \quad (4.49)$$

with $T_e(P) = \frac{|I|^2 R}{\rho \nu c A} + T_o$ the equilibrium temperature if $t \rightarrow \infty$. This derivation is derived for $|I|$ constant which is not the case in a real power grid. In the power grid model we take $|I|$ constant for a fixed time and use equation (4.49) to calculate the temperature increase during this time. In the next timestep we take $T(0)$ as the final temperature in the previous timestep. Then we calculate the temperature in the next timestep by equation (4.49) in which we can have a different constant current.

In Chapter 3 we discussed the Neher-McGrath equation which led to an expression for the equilibrium temperature of a cable conductor under a constant current (3.2). In deriving equation (4.49) we

have assumed a conductor without insulation and therefore we found a different equilibrium temperature. When we compare both equations we can deduce some implicit assumptions we have made in equation (4.49),

- the dielectric losses in the insulation are small, $\Delta T_d \ll 1$, and
- the thermal resistance of the thermal circuit in the cable insulation is approximately the thermal resistance of the earth, $\bar{R}'_{ca} \approx \frac{1}{\rho \nu c A}$.
- The cable is buried at a depth such that the heating of the soil is not influenced by the air above the earth.

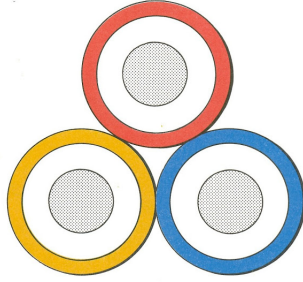

Figure 14: Three phase power cables in a trefoil formation

We also note that the derivation we have used is valid for a single cable. In three phase power flow we have three cables close to each other. We will consider the case where the cables are laid in a trefoil formation as shown in Figure 14. We see that the trefoil formation means that the cables are laid together in a triangle. All three cables produce heat and therefore the center of the trefoil will also heat up. Therefore the heat flux from a cable to the center of the trefoil will be negligible. We model this by assuming that a cable cannot lose heat through one third of its perimeter. This leads to the following equation for the equilibrium temperature of a cable in a trefoil formation

$$T_e(P) = \frac{3|I|^2 R}{2\rho \nu c A} + T_o \quad (4.50)$$

Direct failure Now we have considered the temperature development of the cables in the distribution grid we can discuss the failures occurring from heating in the cables. As we have noted before we can distinguish two failures related to the temperature of a cable, direct failure and thermal aging. We will discuss the thermal aging of a cable later in this chapter and focus on the direct failure for now. The direct failure is caused by the melting of the insulation of the cable. If we exceed the maximal temperature T_{\max} the insulation will melt. The melting will first induce deformations in the insulation and eventually will cause the conductor to make contact to the earth. If the conductor makes contact to the earth we will have an outage. If only deformations occur we do not necessarily find an outage, but we have changed the internal structure of the insulation implying a very high probability of an outage in the near future. Therefore we will consider this also as a direct failure of the component. We model that component i has an outage when the temperature exceeds the maximal temperature, $T_i \geq T_{\max}$.

Thermal aging We noted that heating of the cable insulation has an effect on the aging of the cable. In order to model this effect we should have some understanding of the process of degradation of an insulation. The insulation is protected from oxidation by an anti-oxidant. This anti-oxidant is used over time in a chemical process and when it has been fully used the insulation has a high chance of failing. At a higher temperature the process using the anti-oxidant will happen faster which means that the component ages quicker. We can determine the effects of the heating by constructing a thermal age \hat{a} . We follow the approach of Karahan et al. [35] to determine the exact equation for the rate of change in

the age of an electric component due to heating. To find the effect of the thermal degradation on the rate of change in the age Arrhenius' equation is used

$$\frac{d\hat{a}}{dt} = Ae^{-\frac{E_a}{k_B T}}, \quad (4.51)$$

which calculates the change in thermal age over time. Here k_B is the Boltzmann constant and T the absolute temperature. We also have two material constants A and E_a where E_a is referred to as the excitation energy measured in eV. We can determine E_a from the insulation used and A from the normal operation conditions of the cable. We can connect this equation to our equation for the temperature in the cable by substituting $T(t)$ in this equation and solve for \hat{a}

$$\hat{a}(t) = A \int_0^t e^{-\frac{E_a}{k_B T(\hat{t})}} d\hat{t}. \quad (4.52)$$

Substituting (4.49) will yield the exact equation for finding the relative age of the component subject to heating. The integral in (4.49) is not easily solved, and therefore we shall use numerical integration. We use the trapezoidal approximation for the thermal aging on the interval $[t, t + \Delta t]$. Then

$$\hat{a}(t + \Delta t) \approx \hat{a}(t) + \frac{A\Delta t}{2}[f(t + \Delta t) + f(t)], \quad (4.53)$$

with

$$f(t + \Delta t) = e^{-\frac{E_a}{k_B T(t + \Delta t)}} \quad (4.54)$$

In the model we will use the thermal age as the actual age of the component. The aging of the component as given in equation (4.52) only depends on the thermal processes but in the real world several other process play a role in the aging of the component. We assume that at a high temperature the thermal aging governs the aging of the component and we use the following equation for the age after the interval $[t, t + \Delta t]$,

$$a(t + \Delta t) \approx a(t) + \frac{\Delta t}{2} \max \left\{ \begin{array}{l} A[f(t + \Delta t) + f(t)] \\ 1 \end{array} \right. . \quad (4.55)$$

In the model we model a failure of component i at time t^* if the thermal age $a_i(t^*)$ of the component equals the failure age \bar{a}_i as found in equation (4.46), $a_i(t^*) = \bar{a}_i$.

4.4 Model for repairing components

When an outage occurs in the grid the power can not be transported through the component that is broken. This means that customers can not receive or deliver power during a certain time. In the grid of Westland Infra it is possible to circumvent the broken component. The segment in Figure 12 has one connection to the higher part of the grid through the substation. In general all sections in the grid of Westland Infra have two of these substations. These substations generally consist of a set of switch gears which determine the routes that are open for power flow. When a segment is connected to two different substations the grid operator makes sure that the cycle emerging from this situation is broken to prevent the system from circulating flows. Having the possibility to a cycle does mean that in the case of a broken link, the cycle can be restored to ensure that every customer will receive power. Therefore we can always treat a segment as connected to one substation with the ability to restore the power flow in case of an outage of maintenance. Rerouting the power is done manually in most of the cases, therefore a brief interruption in the power supply is experienced and the customer does know that an outage has occurred. We keep track of the number of customers and the amount of connection capacity hit by an outage. In the model we predefined the actions of the DSO when an outage occurs in the grid.

In the case of a random or aging outage

- at a cable section, we replace the entire section. This has the consequence that we reset the age of the section.

- at a cable joint, we replace the entire joint. This has the consequence that we reset the age and the percentage corrosion of the joint.

In the case of a direct outage due to the temperature

- at a cable section, we replace and double the number of cables of the entire edge. This measure is used as a penalty to prevent the DSO from consistently waiting until the cable melts. The age of all the components of the edge is again set to zero just as the corrosion for every joint at the line.
- at a cable joint, we replace the entire joint. This has the consequence that we reset the age and the percentage corrosion of the component.

In the case that a line consists of more than one cable the specified action is conducted for all cables.

4.5 Cost model

There are several types of costs associated with operating the distribution grid. In this investigation we will focus on the costs made for investments in the grid and the costs induced by transportation losses. The investment costs are costs made for replacing or adding components. The costs are split in two parts, first we will define fixed costs. The fixed costs are the costs that we have whenever we want to replace a component (e.g. employees, digging, equipment). The second part of the costs are the costs of a single component, which we call the variable costs. The variable costs depend on the number of cables at the line. The costs also differ between the joints and the cable sections. The costs of replacing or adding a joint depends only on the type of the joint. We consider only XLPE insulated pressed joints and therefore the investment costs related to replacing n_j joints at point j can be expressed as

$$C_j = C_{j,\text{fixed}} + n_j \cdot C_{j,\text{variable}}. \quad (4.56)$$

The cable joints are interchangeable, but the cable sections are not. The cable sections all have a different length and this induces different costs. When we have to replace a longer component we will have to dig more and longer and we will also need more material for the new cable section. Therefore we have at section i of length l_i in meters investment costs for replacing n_i cables of

$$C_i = l_i(\hat{C}_{i,\text{fixed}} + n_i \cdot \hat{C}_{i,\text{variable}}). \quad (4.57)$$

In this equation $\hat{C}_{i,\text{fixed}}$ and $\hat{C}_{i,\text{variable}}$ are costs per meter. The costs of replacing or adding components are considered as CAPEX.

The transportation losses are costs we have because a part of the power that goes in to the grid is used for heating the cables. In equation (4.12) we have derived the amount of power that is lost on a single cable with impedance Z and current I . As seen in Chapter 2 (equation (2.6)) only the real power is consumed by the consumer. Further the complex part of the power losses is also negligible compared to the real part. Therefore we neglect the costs due to complex power losses and we use the following equation for the real power lost in a cable with resistance R

$$P_{\text{loss}} = |I|^2 R. \quad (4.58)$$

When we consider an edge of our model, the power lost in that edge is the number of cables times the power lost in one cable. The costs of the transportation losses on edge i with n_i cables under constant current I in t hours is then given by

$$C_{j,\text{trans}} = n_i C_{\text{kWh}} |I|^2 R t \cdot 10^{-3}. \quad (4.59)$$

$C_{\text{kWh}} = \text{€}0.07$ is the cost that the DSO has for losing one kWh of energy. The transportation losses are ongoing costs of the distribution grid and can be classified as OPEX costs.

We have neglected a lot of the costs in operating the distribution grid, either to show the impact of transportation losses or because they are considered small in our set-up. We do want to note two other

costs in the distribution grid. First of all we want to mention the cost of money. With the costs of money we mean the idea that having money now is better than having the same amount money at a later time. This mechanism is caused by inflation and the possibility to gain interest over money. We have neglected these costs in the model, but we should keep in mind that the costs of money can have a big impact when large investment costs are considered over a large period of time. Secondly we consider the Value of Lost Load (VoLL) [36]. The VoLL is considered equivalent to the minimum amount a customer wants to receive as a compensation for not receiving power or the maximum amount they want to pay to avoid the loss of load. This can be determined using surveys under different customer groups or estimated using assumptions and historical data. The sizing of the grid in our model makes the VoLL negligible compared to the investment costs in the grid. However, as we have noted the grid is changing. With a further increase of distributed generation and future smart grid applications the Value of Lost Load may become a greater issue and comparable to investment costs.

Chapter 5

Maintenance models

Do we want to add cables such that the entire grid runs at 50% of the allowed load? Do we want to wait until a joint melts before we replace it? And how do we know when we should act? These are a couple of questions that can be asked within a DSO. These answers are generally not easy and have a big impact on the grid. The answers to these questions lead to policies of the DSO regarding the distribution grid. We consider a policy as a set of rules regarding investments in the distribution grid.

Usually the rules of a policy are constructed using the peak current at certain points in the grid. For instance, a rule can be that the peak current of a cable should be below 550 A. In order to check if this rule is violated we should be able to measure the peak current at the cable. Most of the rules are based on such measurements of peak load. This has as a drawback that not all technical effects of the decisions are accounted for. In order to evaluate this drawback we will develop a method for making maintenance decisions based on continuous measurements of current and temperature in the grid. We will start by briefly explaining the used sensors and where they are placed. Next we will consider some limitations of the sensors and how we deal with these. We will continue with an explanation on how to use the data from the sensors. At last we will construct a mathematical model that analyses the data using stochastic power flow equations.

5.1 Measurements and basic equations

In this chapter we will consider one hypothetical type of sensor. The idea of this sensor is based on developments at Westland Infra towards a temperature sensor. The sensor of Westland Infra measures the temperature of a cable joint and is placed on the insulation of the joint. We assume that our hypothetical sensors can also determine the current flowing through the cable (e.g. by measuring the electric field around the cable). Furthermore we assume that all joints are equipped with such a sensor. Figure 15 gives an impression of a branch equipped with sensors. In practice we receive data from the

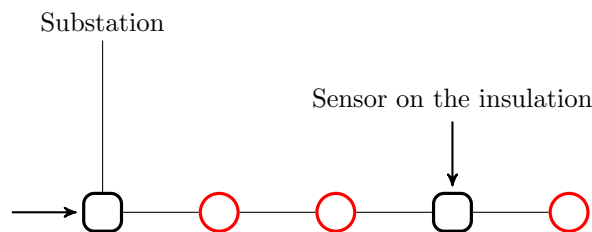

Figure 15: Graphical representation of a branch of the distribution grid with the locations of the sensors. Load buses are represented by red circles and cable joints by black rectangles.

sensors at fixed times. At time t_n we receive the temperature $T(t_n)$, absolute current $|I(t_n)|$ and current direction $\delta(t_n)$. We define the evenly spaced time between the arrival of these data points as Δt . We

can use the data from the sensor to extract information of the cable joint in the interval $[t_n, t_{n+1}]$. In this section we will consider three parameters that can be determined from the measurements.

Corrosion In the following way we can derive the effects of corrosion directly from the measurements and information about the cable joint. First we adjust the equation for temperature (4.49)

$$T(t_{n+1}) = e^{-\nu\Delta t}(T(t_n) - T_e(P(t_n))) + T_e(P(t_n)), \quad (5.1)$$

which gives us a relation between the data points. The equilibrium temperature in the interval is assumed to be

$$T_e(P(t_n)) = \frac{3|I(t_n)|^2 R(t_n)}{2\rho\nu cA} + T_o, \quad (5.2)$$

based on equation (4.50), here is assumed that the outside temperature T_o is constant. In this equation we used $R(t_n)$ to account for the time dependent corrosion of the joint. We can rewrite equation (5.1) to find the time dependent resistance

$$R(t_n) = \frac{2HO}{3|I(t_n)|^2} \left(\frac{T(t_{n+1}) - e^{\nu\Delta t}T(t_n)}{1 - e^{-\nu\Delta t}} - T_o \right), \quad (5.3)$$

in this derivation we have used that $\nu = \frac{HO}{\rho cA}$.

Power losses We can also gain information on the power lost in a cable. For this purpose we assume that the cable has a fixed resistance per meter, R . We can assume this despite the previous consideration of corrosion because the length of the cable is far longer than the length of the joint. Therefore corrosion in the joint will not account for a significant loss of power in the cable. We calculate the power lost in a meter cable in the time interval $[t_n, t_{n+1}]$ using the following equation based on (4.58),

$$\hat{P}_{\text{loss}}(t_n) = |I(t_n)|^2 R \Delta t. \quad (5.4)$$

Thermal age We will now consider a parameter that can be determined by only measuring the temperature of the joint. This parameter is the relative age of the joint as considered in equation (4.52). We can adjust the trapezoidal approximation (4.53) for using the data from the temperature sensors

$$\hat{a}(t_{n+1}) \approx \hat{a}(t_n) + \frac{\Delta t}{2} \max \left\{ \begin{array}{l} A[f(t_{n+1}) + f(t_n)] \\ 1 \end{array} \right. , \quad (5.5)$$

where

$$f(t_n) = e^{-\frac{E_a}{k_B T(t_n)}}. \quad (5.6)$$

We can also keep track of the relative age of the cable sections by noting that the temperature of such a section is given by

$$T(t_{n+1}) = e^{-\nu\Delta t}(T(t_n) - T_e(P_{\text{loss}}(t_n))) + T_e(P_{\text{loss}}(t_n)), \quad (5.7)$$

and $P_{\text{loss}} = \frac{\hat{P}_{\text{loss}}}{\Delta t}$. So from measuring the temperature and current in a cable joint we can find information on the corrosion in the joint, the power lost in the cable and the thermal age of the joint and the cable.

5.1.1 Residual Grid and input power computation

As we can see from Figure 15 we do not obtain full information of the grid by measuring at the joints. Therefore we will not consider the entire grid, but only a residual grid. The residual grid is constructed from the original grid by neglecting the cables where we have no joints. We define the graphical representation of the residual grid as the residual graph \bar{G} . The residual graph is constructed from G

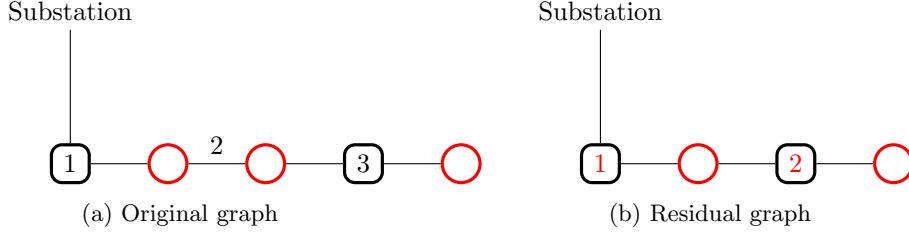

Figure 16: Construction of the residual graph (b) from the original graph (a) and renumbering of the cables.

by removing every edge $e = (e_i, e_f)$ without a sensor and joining the nodes e_i and e_f together. This construction means that we keep all of the information of the edges with sensors present, but we lose information of the other edges and the nodes connected to those edges. The construction of a residual grid using the graphical representation is shown in Figure 16. Because we neglect the cables without joints we also neglect the power factor of these cables. We assume that the power factor of the cables has small influence on the overall power factor, we do this because the neglected cables are short and will not consume a lot of power. So we assume that the power factor of nodes in the residual grid is the same as in the original grid.

Now that we have constructed the residual grid, we can obtain information on the nodes in this grid. Suppose we have a radial residual graph of $M + 1$ nodes and M edges. This means that we have M load buses and one slack bus in the residual grid. Because we have sensors at every cable in the residual grid at time t_n we know $T_m(t_n)$, $|I_m(t_n)|$ and $\delta_m(t_n)$ for every edge m in the residual graph. However we are interested in the input power vector $\mathbf{W}(t_n)$ from equation (4.42). We only have information on the power flow at the position of the sensors. Therefore we have constructed Algorithm 1 for finding $\mathbf{W}(t_n)$ from the measured current.

Algorithm 1

- 1: Input: vector of measured currents $|I|$, vector of measured flow directions δ , vector of cable lengths \mathbf{l} , cable resistance R , cable reactance X , power factor $\cos(\varphi)$.
 - 2: $\mathbf{P} \leftarrow \emptyset, \mathbf{Q} \leftarrow \emptyset$
 - 3: $|V_0| = 20 \cdot 10^3$
 - 4: **for** $i = 1 : M$ **do**
 - 5: $\Delta|V_i| \leftarrow \delta_i |I_i| l_i \sqrt{\frac{R^2 + X^2}{3}}$
 - 6: $|V_i| = |V_{i-1}| - \Delta|V_i|$
 - 7: **end for**
 - 8: $P_M^{\text{out}} \leftarrow 0, Q_M^{\text{out}} \leftarrow 0,$
 - 9: **for** $i = 0 : M - 1$ **do**
 - 10: $P_{M-i}^{\text{in}} \leftarrow \sqrt{3} |I_{M-i}| |V_{M-i}| \cos(\varphi), Q_{M-i}^{\text{in}} \leftarrow \sqrt{3} |I_{M-i}| |V_{M-i}| \sin(\varphi)$
 - 11: $P_{M-i} \leftarrow P_{M-i}^{\text{in}} - P_{M-i}^{\text{out}}, Q_{M-i} \leftarrow Q_{M-i}^{\text{in}} - Q_{M-i}^{\text{out}}$
 - 12: $P_{M-i}^{\text{out}} \leftarrow \sqrt{3} |I_{M-i}| |V_{M-i+1}| \cos(\varphi), Q_{M-i}^{\text{out}} \leftarrow \sqrt{3} |I_{M-i}| |V_{M-i+1}| \sin(\varphi)$
 - 13: $\mathbf{P} \leftarrow \mathbf{P} \cup \{P_i\}, \mathbf{Q} \leftarrow \mathbf{Q} \cup \{Q_i\}$
 - 14: **end for**
 - 15: Output: $\mathbf{W} \leftarrow \begin{bmatrix} \mathbf{P} \\ \mathbf{Q} \end{bmatrix}$
-

Algorithm 1 is based on the fact that the current in a cable can be considered constant and power losses decrease the voltage. We measure the absolute current at the cables and the direction of the current. Therefore we know the absolute current entering and leaving the nodes. We also use the vector of cable lengths \mathbf{l} , the resistance and reactance of the cables and the power factor at the nodes as input variables. In every step of the algorithm we consider a different cable, starting with the cable closest to the substation. We calculate the voltage loss in the system such that we know the voltage at the every node. Then we reverse the loop and start at the cable furthest from the substation. We calculate the power flowing out of the end node and into the start node of the cable from the current in the cable

and equations (2.4)-(2.5). We use that at every node the power factor is φ . The difference between the power flowing in to the node and out of the node is the input power of the node. Finally we can combine all input powers to find the input power vector $\mathbf{W}(t_n)$.

5.2 Proactive maintenance model

In our proactive maintenance model we want to use measurements from the hypothetical sensors as a control system for heat losses and internal failures. By using temperature sensors we can see when a joint is going to melt. So we assume that we are able to react to melting joints and reroute the power such that customers do not see an outage. Therefore we do not have to replace these joints but this does not induce a failure as noticed by the customer. Furthermore we will develop a method that uses the information gained from the measurements to show economical and technical effects on the grid. We assign an action to the grid at a certain time. In this Chapter we will consider a method that uses the expected number of failures and the expected costs as decision parameters. As actions we use the number of cables a DSO adds in the grid. Adding a cable to line i has no effect on the other lines in the grid and therefore we determine the actions for every line independently of each other. This property decreases the complexity of the problem.

First we will discuss the general structure of the proactive maintenance model. We want to determine a policy in the interval $[0, T_{\text{end}}]$. Therefore we discretize the interval with step size T_{dec} and we want to determine an action of the DSO after every step. We specify $A^i(t)$ as the set of possible actions at time t for line i . The actions in the set denote how many cables we add to line i at time t . This means that we can write the action set as $A^i(t) = \{0, 1, \dots, K_{\text{max},i}(t)\}$, where $K_{\text{max},i}(t)$ is the maximum amount of cables we can add to line i at time t . The system is different at every decision time and therefore we have a different input at every decision time. Such a problem is normally modeled as a Markov decision process¹ and solved using dynamic programming². However, we have to deal with the complex power flow equations. It is hard to derive probability distributions from these equations with probabilistic input and therefore we do not model a Markov decision process. We also do not use dynamic programming as a solution method as this induces a high complexity and also needs complex equations due to the recursive nature. Instead we will use a rolling horizon method.

A rolling horizon method routinely updates the maintenance policy when new data gets available. Such a method has the following structure: Solve the maintenance model and implement only the imminent decisions. At the next time step update the model with new information, solve it and again only implement the decisions of the near future. This method removes the complexity problems of a recursive model. We also want to circumvent the complex probability distributions emerging from the power flow equations. Therefore we will let the model only evaluate an action at the decision time and no later actions. We will determine the optimal action at the decision time with horizon T_{hor} . In the remainder of this section we will model the decision of the rolling horizon method for line i at time t .

In the model we use C as the total cost and F as the total number of failures at the end of the horizon. We approximate the expected total cost $\mathbb{E}[C|a]$ and the expected number of failures $\mathbb{E}[F|a]$ at the end of the horizon given we execute action $a^i \in A^i(t)$ at time t . We use these definitions to create the following rule for determining the action a_{opt}^i at time t

$$a_{\text{opt}}^i = \arg \max_a \min_{a^* \in A^i(t) \setminus \{a\}} \left\{ \alpha \frac{\mathbb{E}[C|a] - \mathbb{E}[C|a^*]}{\mathbb{E}[C|a^*]} + (1 - \alpha) \frac{\mathbb{E}[F|a] - \mathbb{E}[F|a^*]}{\mathbb{E}[F|a^*]} \right\}. \quad (5.8)$$

It is possible that the function we optimize is zero, and that multiple actions have this as minimum. If zero is the optimal value we choose the action that adds the least cables. The function we optimize is a function that compares the performance on the costs and failures of two possible actions. This is done percentually because the costs and failures are on different scales. The parameter α is used to

¹A Markov decision process is used to model decision making in situations where outcomes are partly random and partly controlled by a decision maker.

²Dynamic programming is a method for solving complex problems by breaking them down into simpler subproblems. In mathematical optimization this relates to simplifying a decision by breaking it down into decision steps over time. This is usually done by means of a backwards relation in time.

put an emphasize on either the costs or the failures. In the minimization we find for every action a the action a^* which performs best compared to a . Then we maximize over all actions a to find a_{opt}^i . This maximization ensures that we take the action that performs best compared to all other actions. Because the size of $|A^i(t)| = K_{\text{max},i}$ is small we can determine a_{opt}^i with a low complexity by searching through $A^i(t)$.

We have constructed the optimization criterion of the proactive model. We continue with the calculation of the expectation values. We are not able to determine these values exactly because of the many parameters and functions involved in power flow analysis. Therefore we will approximate these values. From Algorithm 1 we calculate the demands \mathbf{W}_0 at time $t = 0$ when we make our decision. In this method we suppose that we know $\mathbb{E}[\mathbf{W}_t|\mathbf{W}_0]$ and $\text{Cov}(\mathbf{W}_t|\mathbf{W}_0)$, the expectation value and covariance of the power demands given the initial demands at $t = 0$. We discretize the horizon in J sections (which have to be periods of entire days), $t = j\Delta t_{\text{hor}}$ where $j = 0, 1, \dots, J$. In these sections we keep the daily load patterns constant. The load patterns are allowed to change between sections. Now we approximate the expected costs in interval j , $[t_j, t_{j+1}] = [j\Delta t_{\text{hor}}, (j+1)\Delta t_{\text{hor}}]$,

$$\bar{C}_j = \sum_i \mathbb{E}[P_{\text{loss},i}|\mathbf{W}_0] \cdot 0.07 \cdot \Delta t_{\text{hor}} + \sum_c \bar{F}_{c,j}(C_c) \quad (5.9)$$

This equation uses the approximation of the expected number of failures of component c in the interval, $\bar{F}_{c,j}$ and investment costs related to the failure of component c , C_c . We approximate the total expected costs by summing this equation and adding the investment costs of executing action a , \bar{C}_a

$$\mathbb{E}[C|\mathbf{W}_0] \approx \bar{C} = \sum_j \bar{C}_j + \bar{C}_a. \quad (5.10)$$

Now we will determine the approximation of the total number of failures, \bar{F} . We start with calculating the total number of failures of component c in interval j , $\bar{F}_{c,j}$. We split $\bar{F}_{c,j}$ into the number of random failures $RF_{c,j}$ and the number of aging failures $AF_{c,j}$.

$$\bar{F}_{c,j} = RF_{c,j} + AF_{c,j}, \quad (5.11)$$

We can use equation (4.44) to define approximation of the expected number of random variables of component c as

$$RF_{c,j} = \mathbb{E}[\text{Random failures in } [t_j, t_{j+1}]] = \lambda_{fc}\Delta t_{\text{hor}}, \quad (5.12)$$

and we use equation (4.46) for the number of aging failures of component c in interval j

$$AF_{c,j} = F(\bar{A}_{c,j}) - F(\bar{A}_{c,j+1}), \quad (5.13)$$

where $\bar{A}_{c,j}$ approximates the thermal age of the component at time $j\Delta t_{\text{hor}}$ and $F(\bar{A}_{c,j})$ is the cumulative Weibull distribution, which is given by

$$F(\bar{A}_{c,j-1}) = 1 - e^{-\left(\frac{\bar{A}_{c,j-1}}{\beta}\right)^\eta}. \quad (5.14)$$

We approximate the expected number of failures by summing over all intervals and all components

$$\mathbb{E}[F|\mathbf{W}_0] \approx \bar{F} = \sum_j \sum_c \bar{F}_{c,j}. \quad (5.15)$$

We continue with the approximation of the age of component c after interval j , $\bar{A}_{c,j}$. The increase of the age in an interval depends on the temperature of the component during the interval. We know how to calculate the daily increase when we divide the day in U parts. We use equation (4.55) to approximate the increase in age during the period $[t_j, t_{j+1}]$.

$$d\bar{A}_{c,j} = \Delta t_{\text{hor}} \frac{\Delta t_{\text{day}}}{2} \sum_{u=0}^{U-1} \max \left\{ \begin{array}{l} A \left[e^{-\frac{E_a}{k_B T(t_{u+1}, \mathbb{E}[P_{\text{loss},c]}^{u+1})}} + e^{-\frac{E_a}{k_B T(t_u, \mathbb{E}[P_{\text{loss},c]}^u)}} \right] \\ 1 \end{array} \right\}, \quad (5.16)$$

in this equation $\Delta t_{\text{day}} = \frac{24}{U}$. We calculate the daily increase in age and then multiply this with the number of days in the period. We can do this because we assumed that the daily load profile does not change during this period. Now we use (4.49) to define

$$T(t_{\text{day}}, \mathbb{E}[P_{\text{loss},c}^u]) = e^{-\nu \Delta t} (T(t_{u-1}) - T_e(\mathbb{E}[P_{\text{loss},c}^u])) + T_e(\mathbb{E}[P_{\text{loss},c}^u]). \quad (5.17)$$

We note that in general we do not know $T(0)$. Therefore we construct this initial value from the assumption that the daily load pattern in the period $[t_j, t_{j+1}]$ does not change. This means that we can use the expectation of the daily losses $\mathbb{E}[P_{\text{loss},c}^u]$ at component i together with the observation that in an unchanging load pattern the temperature should follow a periodic rule, $T(0) = T(t_U)$. In Algorithm 2 we construct an initial value using these two observations. The algorithm converges and $|T(t_U) - T(0)| < \epsilon$. We compute $\bar{A}_{c,j}$ by adding the increase in age for every interval $l < j$ but we set the age to zero when

Algorithm 2

```

1:  $T(0) \leftarrow 288, \delta \leftarrow 2\epsilon$ 
2:  $T^* \leftarrow T(0)$ 
3: while  $\delta > \epsilon$  do
4:   for  $i = 1:U$  do
5:      $T^* \leftarrow e^{-\nu \Delta t_U} (T^*) - T_e(P_{\text{loss}}^u) + T_e(P_{\text{loss}}^u),$ 
6:   end for
7:    $\delta \leftarrow ||T^* - T(0)||$ 
8:    $T(0) \leftarrow T^*$ 
9: end while
10:  $T(0) \leftarrow T^*$ 

```

a failure occurs. The initial value $\bar{A}_{c,0}$ is given as input variable because with the sensors we are able to keep track of the thermal age of a component.

$$\bar{A}_{c,j} = (1 - \bar{F}_{c,j-1}) \sum_{l=1}^{j-1} d\bar{A}_{i,l} + \bar{A}_{c,0}. \quad (5.18)$$

We assumed that the time interval is short enough to ensure that a component does not fail more than once in the interval.

In equations (5.13) and (5.14) we use the expected power losses. We will calculate these power losses from the expected input power. In order to find the expected power loss of a line (i, j) we first calculate the expected current flowing through that line. We can take the expectation value of Ohm's Law in the line to find

$$\mathbb{E}|I_{ij}| = \mathbb{E} \frac{|S_{ij}|}{|V_{ij}|}. \quad (5.19)$$

We do not consider any transformers in our model of the distribution grid, therefore we can assume that the voltage drop in the grid is negligible. This implies that we consider the voltage to be constant in the entire grid and therefore we will use $\mathbb{E}|V_{ij}| \approx \mathbb{E}|V|$. Now we can use that the constant $\mathbb{E}|V|$ is independent of $\mathbb{E}|P_{ij}|$ and find from equation (5.16)

$$\mathbb{E}|I_{ij}| \approx \frac{\mathbb{E}|S_{ij}|}{\mathbb{E}|V|}. \quad (5.20)$$

The expected power losses over every line are given by taking the expectation value of equation (4.58)

$$\mathbb{E}P_{\text{loss},ij} = \mathbb{E}[|I_{ij}|^2 r_{ij}] \approx \frac{\mathbb{E}[|S_{ij}|^2]}{\mathbb{E}[|V|]^2} r_{ij} \quad (5.21)$$

5.2.1 Stochastic Power Flow Analysis

In order to find the expected power losses we have to compute $\mathbb{E}[|S_{ij}|^2]$. We do this by following a probabilistic three phase power flow approach from Caramia et al. ([37]). We start with power flow equations at time t in the form of equations (4.42,4.43)

$$f(\mathbf{x}) = \mathbf{W}, \quad (5.22)$$

$$\mathbf{Z} = g(\mathbf{x}). \quad (5.23)$$

We know $\mathbb{E}[\mathbf{W}_t|\mathbf{W}_0]$ and we can solve the equations with this input variable,

$$f(\mathbf{x}_o) = \mathbb{E}[\mathbf{W}_t|\mathbf{W}_0], \quad (5.24)$$

$$\mathbf{Z}_o = g(\mathbf{x}_o). \quad (5.25)$$

We can linearize these equations around the state vector \mathbf{x}_o which gives

$$f(\mathbf{x}) \approx f(\mathbf{x}_o) + \left. \frac{df}{d\mathbf{x}} \right|_{\mathbf{x}=\mathbf{x}_o} (\mathbf{x} - \mathbf{x}_o), \quad (5.26)$$

$$g(\mathbf{x}) \approx g(\mathbf{x}_o) + \left. \frac{dg}{d\mathbf{x}} \right|_{\mathbf{x}=\mathbf{x}_o} (\mathbf{x} - \mathbf{x}_o). \quad (5.27)$$

We want to find an expression for the stochastic vectors \mathbf{x} and \mathbf{Z} . We can do this by inverting equation (5.23) and inserting the result into equation (5.24). If the initial problem (5.21)-(5.22) has a feasible solution we know that f^{-1} exists. We can differentiate this function to show that the inverse matrix $\left[\left. \frac{df}{d\mathbf{x}} \right|_{\mathbf{x}=\mathbf{x}_o} \right]^{-1}$ exists and we are allowed to invert equation (5.23). We can now use the following expressions,

$$\mathbf{x} \approx \mathbf{x}_o + \left[\left. \frac{df}{d\mathbf{x}} \right|_{\mathbf{x}=\mathbf{x}_o} \right]^{-1} \Delta \mathbf{W}, \quad (5.28)$$

$$\mathbf{Z} \approx \mathbf{Z}_o + \left. \frac{dg}{d\mathbf{x}} \right|_{\mathbf{x}=\mathbf{x}_o} \left[\left. \frac{df}{d\mathbf{x}} \right|_{\mathbf{x}=\mathbf{x}_o} \right]^{-1} \Delta \mathbf{W}, \quad (5.29)$$

where $\Delta \mathbf{W} = \mathbf{W} - \mathbb{E}[\mathbf{W}_t|\mathbf{W}_0]$.

We have created an expression for the stochastic vectors \mathbf{x}, \mathbf{Z} as a linear combination of a fixed part and a part dependent of the stochastic input vector. When we take the expectation values of (5.25) and (5.26) we find

$$\mathbb{E}\mathbf{x} \approx \mathbf{x}_o, \quad (5.30)$$

$$\mathbb{E}\mathbf{Z} \approx \mathbf{Z}_o. \quad (5.31)$$

We can calculate $\mathbb{E}[|S_{ij}|^2]$ from $\mathbb{E}[\mathbf{Z}]^2$ and the Covariance matrix of \mathbf{Z} which follows from equation (5.26) where we take $A = \left[\left. \frac{df}{d\mathbf{x}} \right|_{\mathbf{x}=\mathbf{x}_o} \right]^{-1}$ and $B = \left. \frac{dg}{d\mathbf{x}} \right|_{\mathbf{x}=\mathbf{x}_o}$,

$$\text{Cov}(\mathbf{Z}) \approx \text{Cov}(\mathbf{Z}_o + AB\Delta \mathbf{W}) = ABC\text{Cov}(\mathbf{W})B^T A^T. \quad (5.32)$$

In the first step we substitute equation (5.26). The second step uses that \mathbf{Z}_o and $\mathbb{E}[\mathbf{W}_t|\mathbf{W}_0]$ are no random variables. We also use that for a p -dimensional random variable \mathbf{X} and a $q \times p$ matrix D the following identity exists

$$\text{Cov}(D\mathbf{X}) = D\text{Cov}(\mathbf{X})D^T. \quad (5.33)$$

We have derived a method to calculate the expected power losses. This method uses the power flow equation with stochastic variables, known as the stochastic power flow equations (5.25,5.26). In order to use his method we need to calculate the matrices A and B . In general this calculation is not easy because in a general power grid we have to consider every possible line connection. However we use that in our grid every connection has at most two lines connected. Then f and g from equations (5.19) and (5.20) are given by

$$f(\mathbf{x})_i = \sum_{k=i-1, i+1} |V_i||V_k|(G_{ik} - \iota B_{ik})(\cos(\theta_i - \theta_k) + \iota \sin(\theta_i - \theta_k)). \quad (5.34)$$

$$g(\mathbf{x})_i = |V_{i_s}||V_{i_e}|((G_{i_e i_s} \cos(\theta_{i_s} - \theta_{i_e}) + B_{i_e i_s} \sin(\theta_{i_s} - \theta_{i_e})) + \iota(G_{i_e i_s} \sin(\theta_{i_s} - \theta_{i_e}) - B_{i_e i_s} \cos(\theta_{i_s} - \theta_{i_e}))), \quad (5.35)$$

where $\mathbf{x} = (\theta, |\mathbf{V}|)^T$ and $i = (i_s, i_e)$ in equation (5.32). For convenience we split the real and complex part of these equations and create new vector functions \hat{f} and \hat{g} . The real part of $f(\mathbf{x})_i$ is stored as $\hat{f}(\mathbf{x})_i$ and the complex part as $\hat{f}(\mathbf{x})_{i+n}$. We do the same for $g(\mathbf{x})_i$ and find the following vector functions

$$\hat{f}(\mathbf{x})_i = \begin{cases} \sum_{k=i-1, i+1} |V_i||V_k|(G_{ik} \cos(\theta_i - \theta_k) + B_{ik} \sin(\theta_i - \theta_k)), & 1 \leq i \leq n \\ \sum_{k=i-n-1, i-n+1} |V_{i-n}||V_k|(G_{(i-n)k} \sin(\theta_{i-n} - \theta_k) - B_{(i-n)k} \cos(\theta_{i-n} - \theta_k)), & n+1 \leq i \leq 2n \end{cases} \quad (5.36)$$

and

$$\hat{g}(\mathbf{x})_i = \begin{cases} |V_{i_s}||V_{i_e}|(G_{i_e i_s} \cos(\theta_{i_s} - \theta_{i_e}) + B_{i_e i_s} \sin(\theta_{i_s} - \theta_{i_e})), & 1 \leq i \leq n \\ |V_{i-n_s}||V_{i-n_e}|(G_{i-n_e i-n_s} \sin(\theta_{i-n_s} - \theta_{i-n_e}) - B_{i-n_s i-n_e} \cos(\theta_{i-n_s} - \theta_{i-n_e})), & n+1 \leq i \leq 2n \end{cases} \quad (5.37)$$

We want to compute the Jacobian matrices of these equations, which are given by the following representations

$$\frac{d\hat{f}(\mathbf{x})}{d\mathbf{x}} = \begin{pmatrix} \frac{\partial \hat{f}_1}{\partial \theta_1} & \cdots & \frac{\partial \hat{f}_1}{\partial \theta_n} & \frac{\partial \hat{f}_1}{\partial |V_1|} & \cdots & \frac{\partial \hat{f}_1}{\partial |V_n|} \\ \vdots & & \vdots & \vdots & & \vdots \\ \frac{\partial \hat{f}_n}{\partial \theta_1} & \cdots & \frac{\partial \hat{f}_n}{\partial \theta_n} & \frac{\partial \hat{f}_n}{\partial |V_1|} & \cdots & \frac{\partial \hat{f}_n}{\partial |V_n|} \\ \frac{\partial \hat{f}_{n+1}}{\partial \theta_1} & \cdots & \frac{\partial \hat{f}_{n+1}}{\partial \theta_n} & \frac{\partial \hat{f}_{n+1}}{\partial |V_1|} & \cdots & \frac{\partial \hat{f}_{n+1}}{\partial |V_n|} \\ \vdots & & \vdots & \vdots & & \vdots \\ \frac{\partial \hat{f}_{2n}}{\partial \theta_1} & \cdots & \frac{\partial \hat{f}_{2n}}{\partial \theta_n} & \frac{\partial \hat{f}_{2n}}{\partial |V_1|} & \cdots & \frac{\partial \hat{f}_{2n}}{\partial |V_n|} \end{pmatrix}, \quad (5.38)$$

$$\frac{d\hat{g}(\mathbf{x})}{d\mathbf{x}} = \begin{pmatrix} \frac{\partial \hat{g}_1}{\partial \theta_1} & \cdots & \frac{\partial \hat{g}_1}{\partial \theta_n} & \frac{\partial \hat{g}_1}{\partial |V_1|} & \cdots & \frac{\partial \hat{g}_1}{\partial |V_n|} \\ \vdots & & \vdots & \vdots & & \vdots \\ \frac{\partial \hat{g}_n}{\partial \theta_1} & \cdots & \frac{\partial \hat{g}_n}{\partial \theta_n} & \frac{\partial \hat{g}_n}{\partial |V_1|} & \cdots & \frac{\partial \hat{g}_n}{\partial |V_n|} \\ \frac{\partial \hat{g}_{n+1}}{\partial \theta_1} & \cdots & \frac{\partial \hat{g}_{n+1}}{\partial \theta_n} & \frac{\partial \hat{g}_{n+1}}{\partial |V_1|} & \cdots & \frac{\partial \hat{g}_{n+1}}{\partial |V_n|} \\ \vdots & & \vdots & \vdots & & \vdots \\ \frac{\partial \hat{g}_{2n}}{\partial \theta_1} & \cdots & \frac{\partial \hat{g}_{2n}}{\partial \theta_n} & \frac{\partial \hat{g}_{2n}}{\partial |V_1|} & \cdots & \frac{\partial \hat{g}_{2n}}{\partial |V_n|} \end{pmatrix}. \quad (5.39)$$

We can simplify the representations of the Jacobians by using the structure of our grid. We have one slack bus with voltage $|V_0|$ and angle θ_0 . We can write down the following equations for the partial

derivatives of $f(\hat{\mathbf{x}})$ and all other derivatives are zero because the links do not exist.

$$\frac{\partial \hat{f}_i}{\partial \theta_j} = \begin{cases} |V_i||V_j|(G_{ij} \sin(\theta_i - \theta_j) - B_{ij} \cos(\theta_i - \theta_j)) & 1 \leq i \leq n & j = i+1, i-1 \\ -|V_{i-n}||V_j|(B_{(i-n)j} \sin(\theta_{i-n} - \theta_j) + G_{(i-n)j} \cos(\theta_{i-n} - \theta_j)) & n+1 \leq i \leq 2n & j = i-n+1, i-n-1 \end{cases} \quad (5.40)$$

$$\frac{\partial \hat{f}_i}{\partial \theta_i} = \begin{cases} \sum_{k=i-1, i+1} |V_i||V_k|(B_{ij} \cos(\theta_i - \theta_k) - G_{ij} \sin(\theta_i - \theta_k)) & 1 \leq i \leq n \\ \sum_{k=i-n-1, i-n+1} |V_{i-n}||V_k|(B_{(i-n)k} \sin(\theta_{i-n} - \theta_k) + G_{(i-n)k} \cos(\theta_{i-n} - \theta_k)) & n+1 \leq i \leq 2n \end{cases} \quad (5.41)$$

$$\frac{\partial \hat{f}_i}{\partial |V_j|} = \begin{cases} |V_i|(G_{ij} \cos(\theta_i - \theta_j) - B_{ij} \sin(\theta_i - \theta_j)) & 1 \leq i \leq n & j = i+1, i-1 \\ |V_{i-n}|(G_{(i-n)j} \sin(\theta_{i-n} - \theta_j) - B_{(i-n)j} \cos(\theta_{i-n} - \theta_j)) & n+1 \leq i \leq 2n & j = i-n+1, i-n-1 \end{cases} \quad (5.42)$$

$$\frac{\partial \hat{f}_i}{\partial |V_i|} = \begin{cases} \sum_{k=i-1, i+1} |V_k|(G_{ik} \cos(\theta_i - \theta_k) + B_{ik} \sin(\theta_i - \theta_k)) & 1 \leq i \leq n \\ \sum_{k=i-n-1, i-n+1} |V_k|(G_{(i-n)k} \sin(\theta_{i-n} - \theta_k) - B_{(i-n)k} \cos(\theta_{i-n} - \theta_k)) & n+1 \leq i \leq 2n \end{cases} \quad (5.43)$$

We can do the same consideration for $\hat{g}(\mathbf{x})$. The nonzero partial derivatives are given by

$$\frac{\partial \hat{g}_i}{\partial \theta_j} = \begin{cases} |V_i||V_j|(B_{ji} \cos(\theta_j - \theta_i) - G_{ji} \sin(\theta_j - \theta_i)) & 1 \leq i \leq n & j = i-1 \\ |V_{i-n}||V_j|(B_{j(i-n)} \sin(\theta_j - \theta_{i-n}) + G_{j(i-n)} \cos(\theta_j - \theta_{i-n})) & n+1 \leq i \leq 2n & j = i-n-1 \end{cases} \quad (5.44)$$

$$\frac{\partial \hat{g}_i}{\partial \theta_i} = \begin{cases} |V_i||V_{i-1}|(G_{(i-1)i} \sin(\theta_{i-1} - \theta_i) - B_{(i-1)i} \cos(\theta_{i-1} - \theta_i)) & 1 \leq i \leq n \\ -|V_{i-n}||V_{i-n-1}|(B_{(i-n-1)(i-n)} \sin(\theta_{i-n-1} - \theta_{i-n}) + G_{(i-n-1)(i-n)} \cos(\theta_{i-n-1} - \theta_{i-n})) & n+1 \leq i \leq 2n \end{cases} \quad (5.45)$$

$$\frac{\partial \hat{g}_i}{\partial |V_j|} = \begin{cases} |V_i|(G_{ji} \cos(\theta_j - \theta_i) + B_{ji} \sin(\theta_j - \theta_i)) & 1 \leq i \leq n & j = i-1 \\ |V_{i-n}|(G_{j(i-n)} \sin(\theta_j - \theta_{i-n}) - B_{j(i-n)} \cos(\theta_j - \theta_{i-n})) & n+1 \leq i \leq 2n & j = i-n-1 \end{cases} \quad (5.46)$$

$$\frac{\partial \hat{g}_i}{\partial |V_i|} = \begin{cases} |V_{i-1}|(G_{(i-1)i} \cos(\theta_{i-1} - \theta_i) + B_{(i-1)i} \sin(\theta_{i-1} - \theta_i)) & 1 \leq i \leq n \\ |V_{i-n-1}|(G_{(i-n-1)(i-n)} \sin(\theta_{i-n-1} - \theta_{i-n}) - B_{(i-n-1)(i-n)} \cos(\theta_{i-n-1} - \theta_{i-n})) & n+1 \leq i \leq 2n \end{cases} \quad (5.47)$$

5.3 Reactive maintenance models

In Chapter 3 we have discussed the reactive and proactive maintenance methods. In this section we will construct three models for reactive maintenance. One model is constructed as a reference, the No Decision model. As its name implies, in this model we make no decisions and therefore we will only do maintenance on cables when a failure has already occurred. This means that in this model we run the simulation with only repairs as specified in Chapter 4. The other models are inspired by the maintenance policies at Westland Infra. We call these models the 450 Capacity and 550 Capacity model. In these models the DSO makes a decision to add new cables at a line if the current exceeds 450 or 550 Ampere. We will again use a rolling horizon method where we only consider an action at the decision time. In these methods we have different optimization criteria. The horizon is again t_{hor}

First we consider the 450 Capacity model. In this model we determine an action for cable (i, j) if $I_{ij} > 450$ Ampere, otherwise our action is to add $a_{\text{opt}}^i = 0$ cables. Then we calculate $\mathbb{E}[I_{ij}]$ at t_{hor} from equations (5.16) and (5.28). Then the number of three phase cables we add to the line a_{opt}^i is given by

$$a_{\text{opt}}^i = \arg \min_a \left\{ a \left\lfloor \frac{\mathbb{E}[I_{ij}]}{a} \right\rfloor < 450, a \in \mathbb{N} \right\}. \quad (5.48)$$

In the 550 Capacity model we determine an action cable (i, j) if $I_{ij} > 550$ Ampere, otherwise our action is to add $a_{\text{opt}}^i = 0$ cables. We again calculate $\mathbb{E}[I_{ij}]$ at t_{hor} and obtain a_{opt}^i as

$$a_{\text{opt}}^i = \arg \min_a \left\{ a \mid \frac{\mathbb{E}[I_{ij}]}{a} < 550, a \in \mathbb{N} \right\}. \quad (5.49)$$

Chapter 6

Simulations and Results

We have described how we model the distribution grid in Chapter 4 and we developed a method to determine the action of a DSO in Chapter 5. In this Chapter we will discuss the simulation method we use and the results obtained from the simulation. In Section 6.1 we will discuss the simulation method. We show some results in Section 6.2 and discuss how these results should be interpreted. The simulations were run using a part of the grid of Westland Infra. All simulations have been performed in Matlab 2012a on a Windows 7 machine with an AMD Dual-Core processor and 8GB memory.

6.1 Simulation method and first results

In this section we will discuss the simulation algorithm and some first results. We will use the schematic representation in Figure 17 to discuss the algorithm. We always simulate a period of 30 years. This is

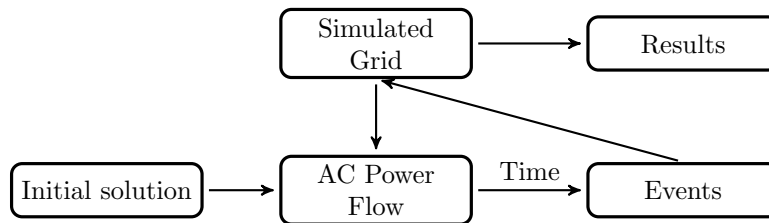

Figure 17: Block diagram of the simulation, every loop of the simulation is a time step.

because 30 years is the lifetime of cables under normal operating conditions. We want to consider the return on investment for adding cables and if the investment is not returned within the lifetime of the cable we have made a bad decision. The algorithm starts with an initial solution. The initial solution is the input of the simulation algorithm. This initial solution is constructed using one warm-up cycle of 90 days such that the system is not in a perfect state. In the next step we compute the stationary AC power flows from the initial solution. This computation is explained in Chapter 4. Next we let time flow, in this time the power flows are considered stationary. We stop the time when an event occurs. These events are stored in an eventlist. The eventlist contains all known events and the time at which these events happen. The events we consider are failure of a component and the possibility to make a decision. The time between two decisions is given by T_{dec} . If the event is making a decision then we execute the maintenance model under consideration with rolling horizon t_{hor} and as input the results of the AC Power Flow equations. The models were discussed in Chapter 5. The model will then return the optimal action. We execute the action corresponding to the event and we update the input powers from customers. This leads to the Simulated Grid. We obtain our results from the simulated grid and it is used as input for the next timestep. The exact simulation algorithm is shown below as Algorithm 3. In the remaining part of this section we will further explain each step of the algorithm.

Algorithm 3 Simulation

- 1: Input: Network in Matpower format, simulation end time T_{end} , decision time T_{dec} , decision parameter α , return on investment time t_{ROI} .
 - 2: $t \leftarrow 0$, eventlist is empty.
 - 3: Add a decision event to the list after every T_{dec} days until we reach T_{end} .
 - 4: Compute for every component the time at which it fails randomly and add the failure events to the eventlist.
 - 5: Compute for every component the age at which it fails and add to the agelist.
 - 6: Sort the eventlist.
 - 7: **while** $t < T_{\text{end}}$ **do**
 - 8: Determine the time dt until the next event and the nature of the event.
 - 9: Compute the power flow pattern for one day.
 - 10: Calculate and store the temperature and age of every component for every day until the event
 - 11: and check if a failure from temperature or age occurs.
 - 12: **if** a failure occurs **then**
 - 13: Calculate the new dt for the current event.
 - 14: For an aging failure, replace the component.
 - 15: For a temperature failure of a cable, replace the cable and double the amount of cables.
 - 16: For a temperature failure of a joint, replace the joint.
 - 17: **else**
 - 18: Process the event:
 - 19: If we have a random failure, replace the component.
 - 20: If we can make a decision, start the decision algorithm with input t_{ROI} and α .
 - 21: Process the decision.
 - 22: **end if**
 - 23: Update the costs, the number of failures, the corrosion, the eventlist and the age list.
 - 24: $t \leftarrow t + dt$
 - 25: **end while**
-

Initial Solution The initial solution is obtained from Westland Infra. The network is based on the circuit 44276 – 44022 on which temperature sensors will be used in 2014. The original circuit consists of two branches connected to a substation. We will only consider one branch. The other branch is modeled as a load bus. A schematic representation without joints of this modified grid is shown in Figure 18. We have also obtained the current maximum demand and production capacity at the load buses. These

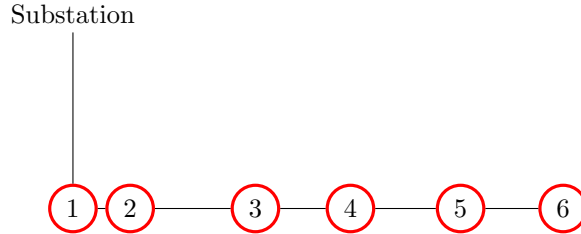

Figure 18: Schematic representation of the circuit 44276 – 44092 where one entire branch is modeled as load bus 1. The joints are omitted in this representation.

capacities are shown in Table 6.1. We can see that the maximum total demand in the circuit is 5,161 MVA and the maximum total production is 13,444 MVA. Furthermore we also know the length of the cables and the exact position of the joints from Westland Infra. In Chapter 4 we assumed one joint every 400 meters, this gives the correct number of joints for cable 1 but not for cable 3. In the simulation we will use the number of joints from our assumption, this will make the circuit more interesting as we now have joints at cables 1 and 3. The length of the cables and the assumed number of joints are shown in Table 6.2. In the simulation we use this network as input in the Matpower format.

Table 6.1: Maximum demand and production capacity of the nodes in circuit 44276 – 44092

Node	Maximum Demand (MVA)	Maximum Production (MVA)
1	3,406	9,600
2	0,107	1,700
3	1,000	0,000
4	0,250	0,000
5	0,250	0,000
6	0,148	2,144

Table 6.2: Length of the cables and the assumed number of joints in circuit 44276 – 44092

Cable	Length (m)	Assumed number of Joints
1	3464	8
2	75	0
3	458	1
4	286	0
5	382	0
6	357	0

We have 6 connections to the circuit 44276 – 44092. These connections have a maximum production and demand capacity, but the load profile was not specified by Westland Infra. Knowledge of the load profile of customer is in general not available at the DSO as it requires sensors at the customer itself. We can only retrieve this information in a grid with smart meters. We do not consider a smart grid and therefore we estimated the load profile at the connections. In this estimation we use the daily load profile from the entire grid of Westland Infra in summer (Figure 4) and winter (Figure 19). We assume that the maximum production capacity is fully used by a customer at peak load. We assume this because the

production capacity is determined by the amount of generators and it will not change rapidly. Therefore the DSO can use the generator capacity of the customer as maximum production capacity. However the consumption of a customer can change rapidly in time. Therefore we assume that the DSO has a margin in the determination of the maximum consumption capacity. In our simulation we use that in the initial solution the maximum demand of a customer is 80% of the maximum consumption capacity. Using these assumptions we translated the load profile of the entire grid to the load profile of one connection. We have shown the load profiles of one connection for summer (Figure 20) and winter (Figure 21). In these figures we have plotted the percentage of the maximum capacity that is used at the connection.

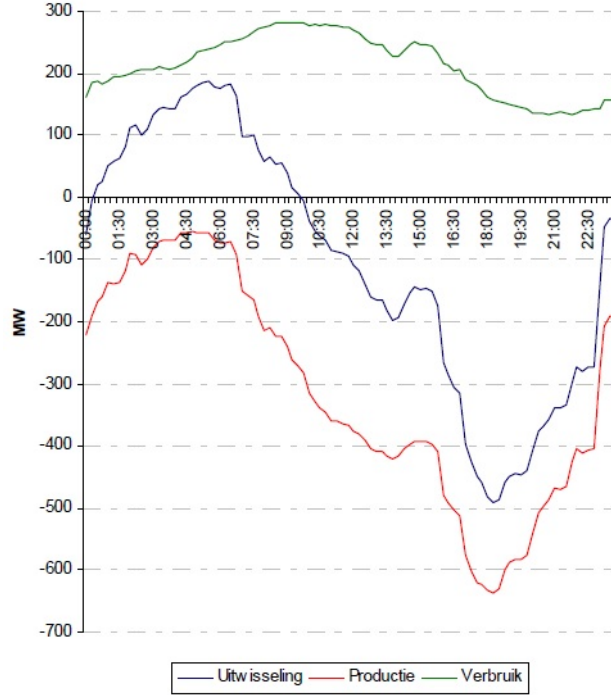

Figure 19: The load profile of the distribution grid of Westland Infra at 27 december 2010. The green line is the consumption, the red line the production and the blue line is the exchange between the transmission grid and the distribution grid. The figure is obtained from [7].

Load profile We have constructed the initial load profile of the connections in terms of the maximum consumption and production capacity. However during the simulation time the load profile of the connections will change. In Chapter 3 we have seen that the production capacity in the grid of Westland Infra tripled in 8 years. Also the consumption of energy increases every year. In The Netherlands the electricity consumption has increased linearly with 51% in the period 1990 – 2012 [38]. In this simulation we want to focus on overload situations due to increased production. Therefore we assume that the peak consumption of connections increases linearly from 80% to 100% of the maximum consumption capacity. We divided the increase in production into three scenarios as shown in Figure 22. Scenario A is a control situation where we have no increase in production. Scenario B and C both see an increase of production capacity during the first 10 years of the simulation. After this period the production capacity stays constant. This is done to simulate what happens when a steep increase in production capacity happens which converges to a stable situation. In Scenario B the final peak production is 140% of the maximum capacity and in scenario C this is 175%. These values are chosen because in scenario B only the 450 Ampere limit is exceeded and in scenario C the current at a cable can exceed 550 Ampere.

Events and Actions Because the AC power flow computation is discussed in Chapter 4 we will continue with the construction of the eventlist. In the eventlist we consider two types of events. These

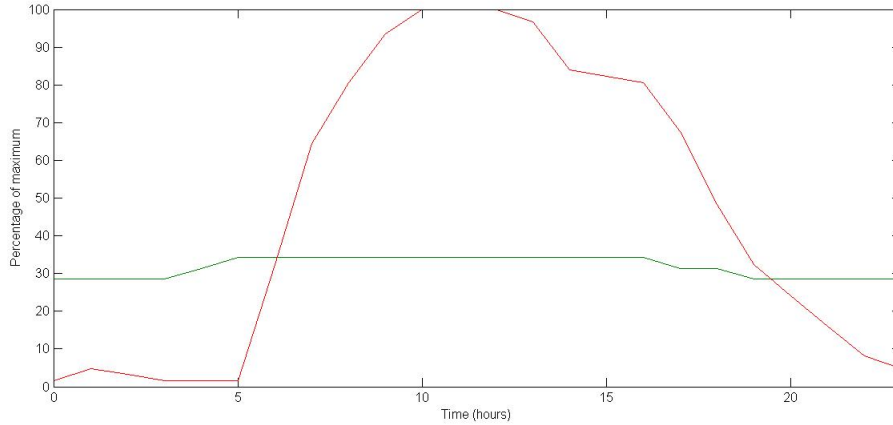

Figure 20: The estimated load profile of a connection in the summer. We have plotted the percentage of the maximum in one day. The green line is the consumption and the red line is the production.

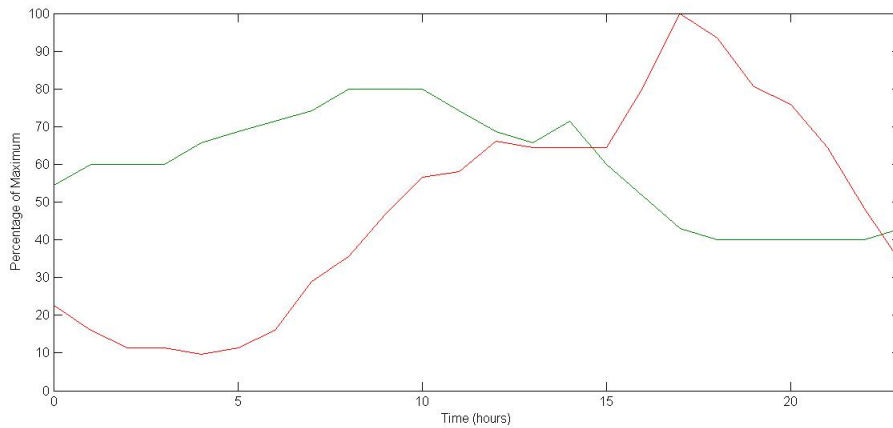

Figure 21: The estimated load profile of a connection in the winter. We have plotted the percentage of the maximum in one day. The green line is the consumption and the red line is the production.

events are the possibility to make a decision and random failures. In our simulations we use $T_{\text{dec}} = 90$ days. This means that we have the possibility to make a decision every 90 days. We chose this time because we do not want too many decisions considering the simulation time and we do want the time to be small enough to prevent large changes in input power between intervals. In the eventlist we have a decision event every 90 days. For the random failure events we use equation (4.45) to determine the next time at which a component fails. We also construct an agelist to keep track of components failing due to the thermal age. At the start of the simulation the ages of failure are determined for every component. When a component has failed due to aging a new age of failure is computed. To compute the age of failure of a component we use the Weibull distribution from equation (4.46).

We do not only consider events, but also actions that can be made by the DSO. We simulate four maintenance models: No Decision, 450 Capacity, 550 Capacity and Proactive. These have been discussed in Chapter 5. For the simulations we need to specify input parameters for these models. In Table 6.3 we have shown which values we use as input parameters in our simulations. We have chosen to use $\alpha = 1$ in the proactive model to find short return on investment times. In the all models we assumed that we know $\mathbb{E}[\mathbf{W}_t | \mathbf{W}_0]$ and $Cov(\mathbf{W}_t | \mathbf{W}_0)$. In the simulations we have made the following choices for these

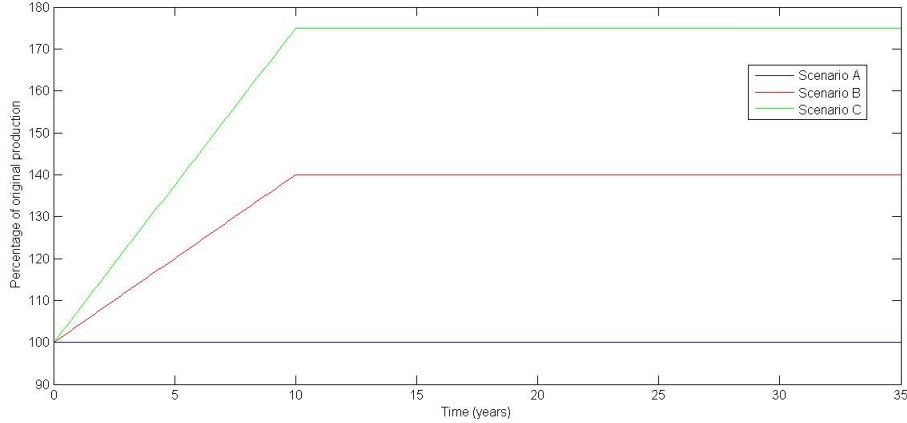

Figure 22: Three different scenarios for the increase of the peak production. Scenario A is given by the blue line, red is scenario B and scenario C is shown by the green line.

parameters

$$\mathbb{E}[\mathbf{W}_t | \mathbf{W}_0] = \left(1 + \frac{0.15t}{15 \cdot 365}\right) \mathbf{W}_0, \quad (6.1)$$

$$\text{Cov}(\mathbf{W}_t | \mathbf{W}_0)_{(i,i)} = 1 \cdot 10^{-11}. \quad (6.2)$$

We have based (6.1) on the increase of capacity that we model in our simulations. The DSO sees an increase of consumption power and a steep increase of production power. In our simulation we have chosen (6.2) to be small. We can assume that the different customers act independently and therefore the covariance is zero. The variance is assumed small to simplify the stochastic power flow computation. In real life the DSO has little information on the behavior of single customers.

Table 6.3: Input parameters for the maintenance models

Input parameters	
Capacity 450	$t_{\text{hor}} = 10$ years
Capacity 550	$t_{\text{hor}} = 10$ years
Proactive	$t_{\text{hor}} = 10$ years, $\alpha = 1$

Table 6.4: Explanation of the numbers that represent events in the timeline of a simulation.

Number	Event
1	Possibility for Decision
2	Random failure of section
3	Random failure of joint
4	Melted cable section
5	Melted cable joint
6	Thermal aging of a component

First results We will briefly consider the output of the simulation. In this investigation we consider the total cost and the total number of failures in the simulation period as the most important results. We

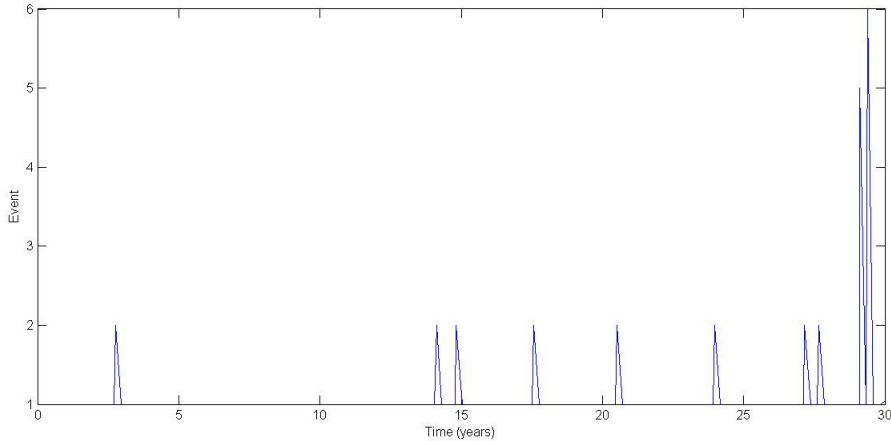

Figure 23: Timeline of a simulation of scenario A under the No Decision model. We have plotted the events against the time in years. In Table 6.4 we show which event corresponds to which number.

will therefore mostly present plots of the total cost and the total number of failures in the simulation. First we will consider the events that happen in one simulation. In Figure 23 we have plotted the timeline of a simulation of scenario A with the No Decision model. We have represented the events as numbers, an explanation of which event corresponds to the number is given in Table 6.4. We will use this representation with numbers in every plot of the events in a simulation. In the simulation of scenario A with the No decision model we see several random failures, one melted joint and one failure due to thermal aging.

We will continue with the plots of the total cumulative cost and the total cumulative failures. In general we will be interested in the total cost and failures at the end of the simulation. Here we show plots of the cumulative cost and failures for every time in the simulation interval to explain how the totals are generated. These plots are generated with different random variables as in Figure 23. We have created graphs of the costs and failures for a simulation of Scenario A where no decisions were made by the DSO. In Figure 24 we show the cumulative costs during the simulation. These costs consist of the cumulative investment costs and the cumulative costs of transportation losses as discussed in Section 4.5. The jumps in Figure 24 are from the investment costs whereas the linear increase comes from the costs of transportation losses. The occurrence of investment costs in the simulation can have different causes. Therefore we show all events in the simulation using a marker. Not all events are visible in Figure 24. This is because some events do not induce high investment costs, for instance replacing a joint. However these events do have an impact on the reliability of the grid. Therefore we also show the cumulative number of failures in Figure 25. This is again plotted against the number of years. We also use markers in this figure to show what kind of failure has occurred.

The two plots that we have shown depict the development of the total cost and number of failures during the simulation. We can also retrieve the general results of the simulation. From Figure 24 we find that the total costs of the grid at the end of the simulation is 3.97 million euro. This is distributed between investment costs (3 million euro) and costs of transportation losses (0.97 million euro). In the simulation 9 random failures occurred, one joint melted and one cable failed due to thermal aging. We can also consider the temperature of the cables, which stayed below 45 degrees the entire simulation. The temperature shows what kind of situation we simulated. During the entire simulation the grid was overdimensioned and therefore we see few failures from melting and thermal aging. In the remainder of this Chapter we will mostly consider information on the costs and the number of failures. However we will also use other parameters to interpret the results and show what kind of situation we simulated.

At last we want to highlight the return on investment time. We define the return on investment time t_{ROI} as the time it takes for an investment to pay off. We want to determine this time for the proactive maintenance method and the 450 and 550 capacity maintenance models. We use the No

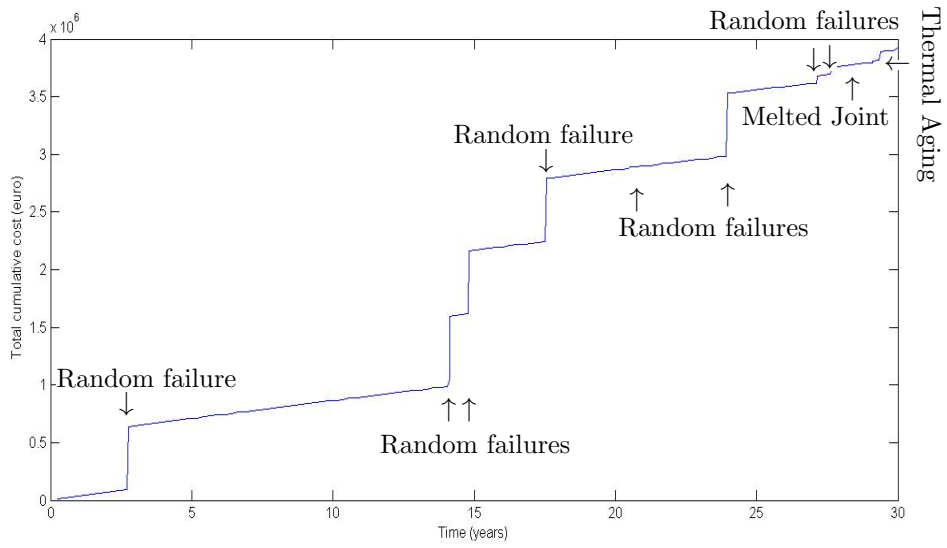

Figure 24: Graph of the total cumulative cost in euro versus the time in years of a simulation with no decisions under scenario A. The blue line depicts the total cumulative costs and the black markers show where events happened.

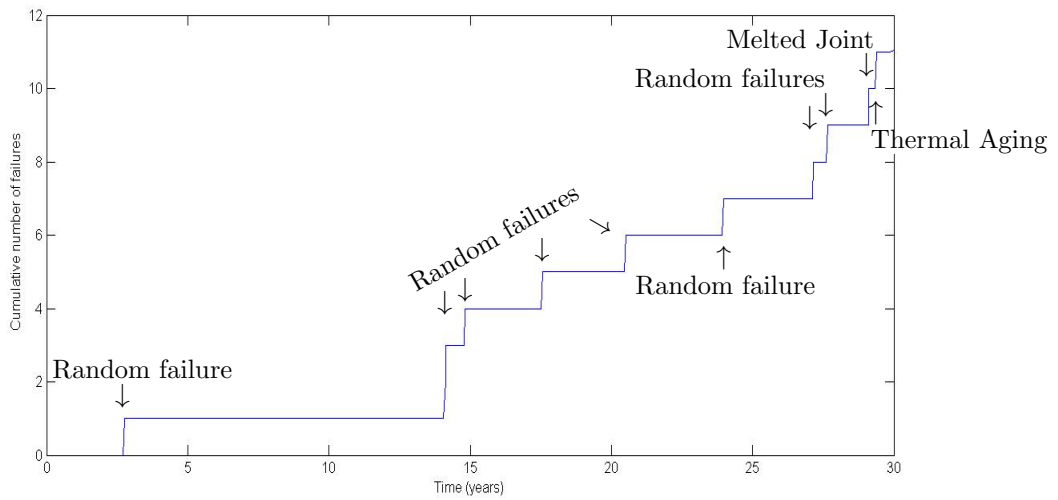

Figure 25: Graph of the cumulative number of failures versus the time in years of a simulation with no decisions under scenario A. The blue line depicts the cumulative number of failures and the black markers show which failures occurred at a time.

decision maintenance model as a reference to determine the profit of an investment as this model never makes an investment and only performs strictly necessary maintenance. We determine the return on investment time by finding the time of the investment t_{invest} and the time at which the investment has paid off compared to the No decision model, t_{return} . The return on investment time is then defined as

$$t_{\text{ROI}} = t_{\text{return}} - t_{\text{invest}}. \quad (6.3)$$

The procedure to determine the return on investment time from the graph of total cumulative cost is shown in Figure 26. In this figure the return on investment time for the 450 Capacity model is determined in scenario B. In this example we find that $t_{\text{ROI}} = 25,1$ years. We can use the same consideration to calculate the return on investment time for the CAPEX costs.

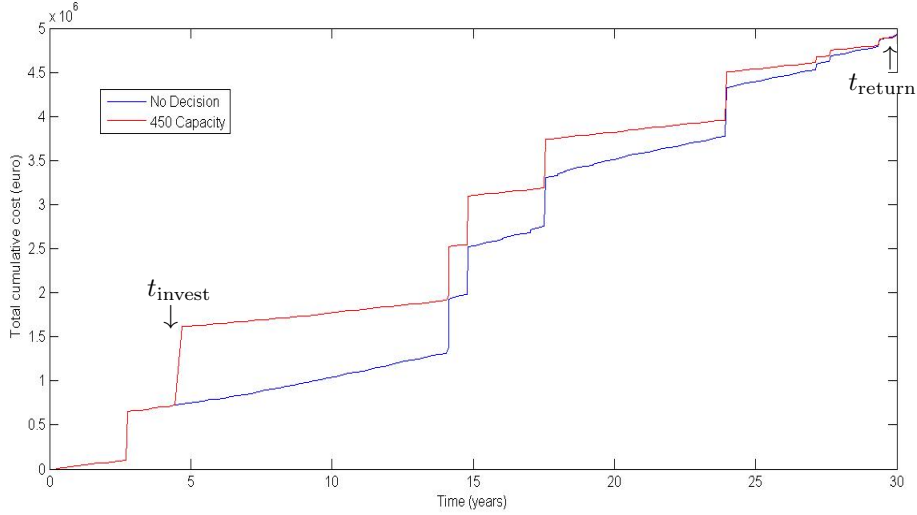

Figure 26: Procedure to determine the return on investment time. We determine the investment time as the moment that the maintenance model takes action. The return time is the intersection between of the cumulative total cost. In this figure the blue line is from the No decision model and the red line from the 450 Capacity model under Scenario B.

6.2 Results

In this section we will present and discuss the main results from simulating the maintenance models under all scenarios. The results are obtained from 5 simulations with different random variables. We will first discuss the results on cost and failures in the grid. Then we will continue and evaluate the return on investment time and the decisions made by the models.

6.2.1 Cost and failures

As mentioned before the costs are made up of transportation losses and investment costs. Figure 27 is a graph of the total cost in euros of all simulated scenarios with all maintenance models. We see that under scenario A the total costs are all equal and under Scenario B the Capacity models perform slightly better. Under Scenario C the No Decision method performs much worse and all other methods keep close together with the Capacity 450 model as the best performer. We can see why the Capacity 450 model has the best performance on total costs when we consider the costs of transportation losses as shown in Table 6.5. In all scenarios this method has the lowest amount of transportation losses. This is consistent with the model as the Capacity 450 model decides to add cables very early. When the

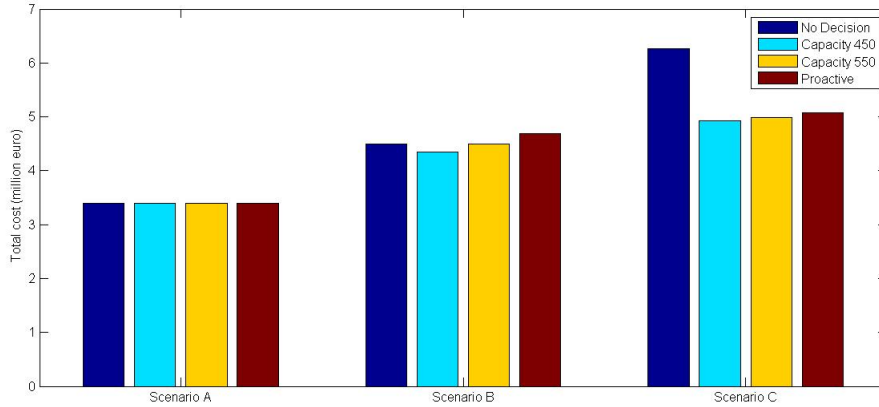

Figure 27: Total cost in million euros for the four different maintenance models under the different scenarios.

Table 6.5: Costs of Transportation Losses in million euro

	Scenario A	Scenario B	Scenario C
No Decision	0.89	1.82	2.93
Capacity 450	0.89	1.03	1.56
Capacity 550	0.89	1.82	1.66
Proactive	0.89	1.31	1.70

transportation costs are considered and measured by the DSO on the long term this method is very good as it diminishes transportation losses early.

The transportation losses already tell us that in Scenario B the Capacity 450 and Proactive model add new cables in the circuit. Under Scenario C all models add new cables, except the No Decision model. We can also see this in the total CAPEX costs made by the different models. The total CAPEX costs are shown in Figure 28. The biggest discrepancy in CAPEX costs is seen in Scenario B. As noted this is due to the Capacity 450 and Proactive model adding a new cable. In Scenario C this discrepancy disappeared as all maintenance models add cables and the No Decision model needs to perform many repairs. This does mean that however the Capacity 450 performs good on total costs, it can generate large CAPEX costs. These costs are balanced due to OPEX costs in the form of transportation losses. The Proactive model seems to perform worst in Scenario B. We will discuss this performance later in this Chapter. The model also always induces the highest total costs. We can explain this due to the high transportation losses as the model always adds cables last.

We also consider the costs that we see in the grid in 15 years after the decision to add a cable in Scenario C. This is shown in Figure 29. In this figure we show the actual costs of the model in the period under consideration, the reference costs under the No Decision model during the same period and the difference between the actual and reference costs. We see that however the Capacity 450 model has the lowest actual costs, it is in a period that we overall have low costs. We can notice that the Proactive method has the highest difference between actual and reference costs. This implies that this method earns the most money in 15 years after adding a cable in Scenario C.

The total number of failures is the second result we will consider. In Figure 30 we have shown the number of failures in the simulation period for every maintenance model. As we would expect, the No Decision model always generates the highest number of failures with as peak the average amount of 349 failures in Scenario C. We can see that adding a cable by the Capacity 450 model in scenario B halves the number of failures. The Proactive model keeps within 1 failure every 30 years. The Proactive model is among the lowest amount of failures in every scenario. So the Capacity 450 model performs best when we consider the OPEX costs and the Proactive model diminishes the number of failures greatly and it

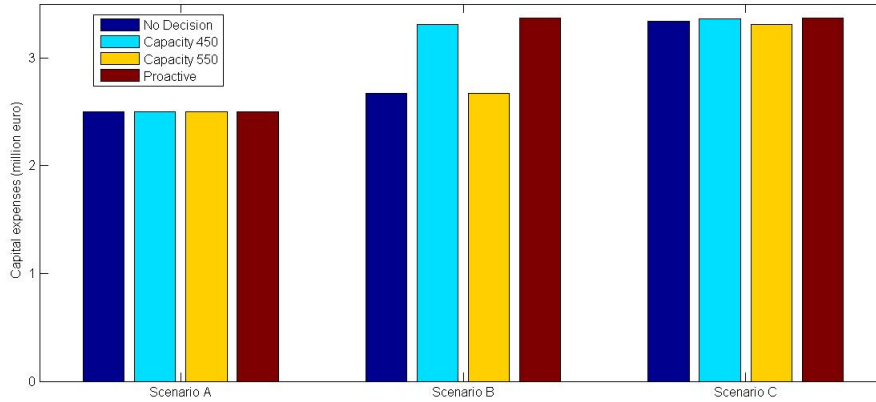

Figure 28: Total CAPEX cost in million euros for the four different maintenance models under the different scenarios.

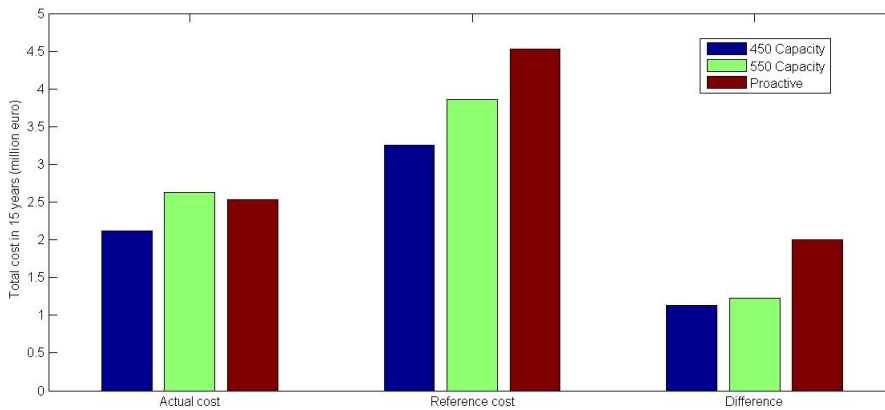

Figure 29: Total cost 15 years after investment for the three maintenance models in Scenario C. We have shown the actual cost, the reference cost in the No Decision model and the difference in million euro.

adds cables later on.

6.2.2 Return on investment and decisions

We will continue by taking a closer look at the decisions made by the different maintenance models. In Scenario C all the models decide to add an extra cable to the grid, but they do this at different times. In Figure 31 we have plotted the timeline of scenario C with the actions made by the different models. We can note that the 450 Capacity model decides to add cables very early. This is consistent with the image we have seen at the results of the total costs. In the period between the action of the 450 Capacity model and the 550 Capacity model the power losses increase. Therefore in this situation the 450 Capacity model has a higher return on investment time when we consider the total costs. The return on investment time for the total costs is shown in Table 6.6. We see that the Proactive model has the best performance with a return on investment time of approximately 10 years. In this scenario the Capacity 550 model profits that it adds cables later and has a return on investment time close to that of the Proactive model.

We have seen that a DSO can split the costs into OPEX and CAPEX. Therefore we also consider

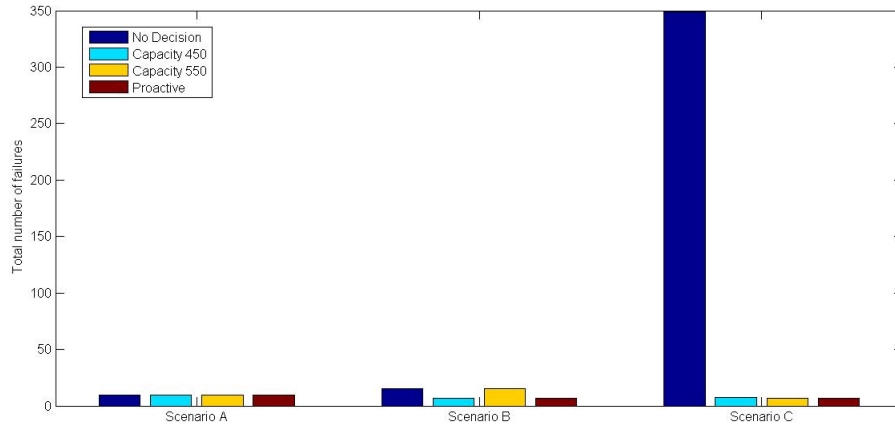

Figure 30: Total number of failures for the four different maintenance models under the different scenarios.

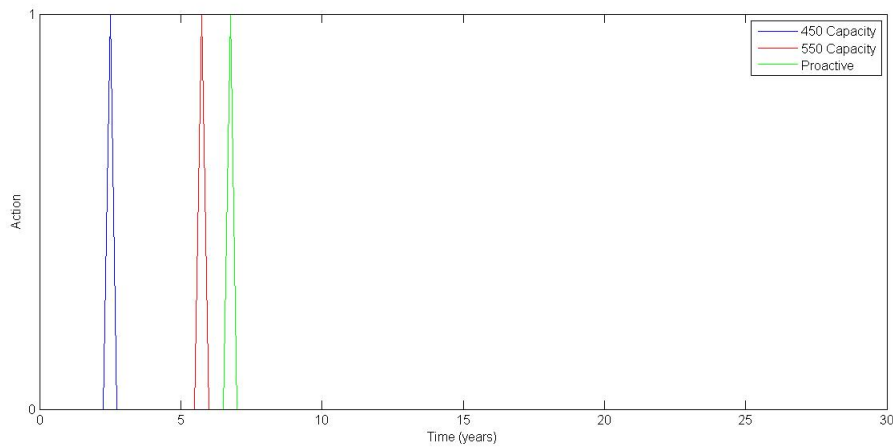

Figure 31: Timeline of actions made by the different maintenance models. We have plotted the number of cables added to line 1 versus the time in years.

Table 6.6: return on investment time under scenario C

Maintenance Model	t_{ROI}
Capacity 450	13.8 year
Capacity 550	11.6 year
Proactive	9.8 year

the return on investment time of the CAPEX. First we take a look at the events that occur in scenario C when we make no actions. In Figure 32 we have plotted the timeline of scenario C with the events of all 5 simulations of the No Decision model. We see that in the period where the cables are added only random failures occur. Therefore we can conclude that t_{return} is the same for all models. From the investment times we can conclude that the return on investment time is again the shortest for the Proactive method and the longest for the Capacity 450 method. In Table 6.7 we have listed t_{return} of the CAPEX for every simulation. In some cases t_{return} falls outside of the simulation period and so we can not reproduce the return on investment time for the CAPEX. We can also deduce that the return

on investment time for CAPEX is at least double the return on investment time for the total costs.

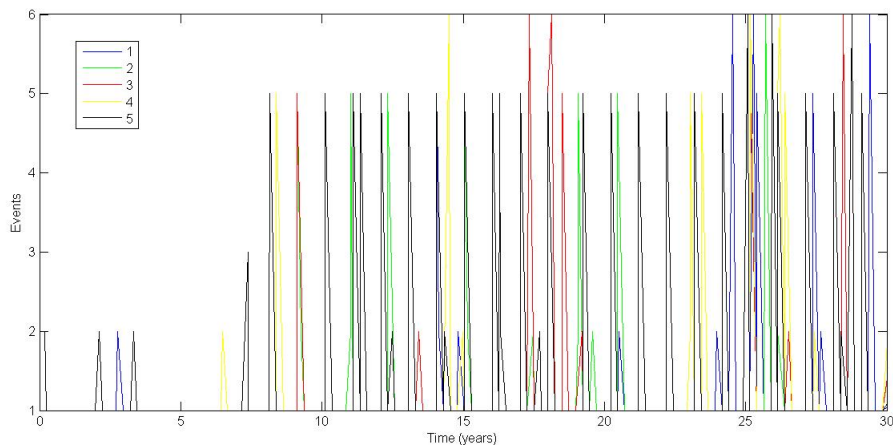

Figure 32: Timeline of actions made by the No decision model in all simulations. We have plotted the reason of interruption versus the time in years.

Table 6.7: t_{return} for the CAPEX costs under scenario C.

Simulation number	t_{return}
1	> 30 year
2	26.1 year
3	28.1 year
4	> 30 year
5	28.1 year

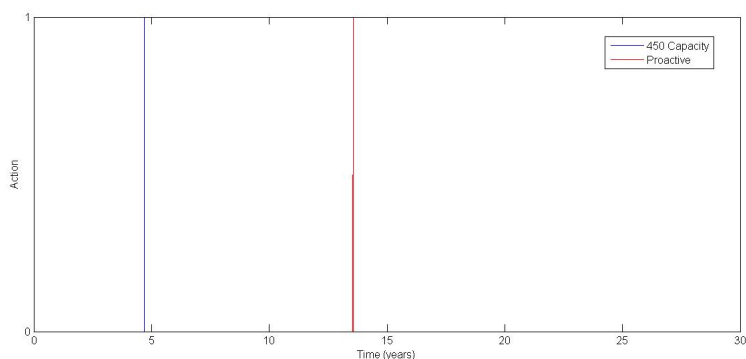

Figure 33: Timeline of actions made by the Capacity 450 and Proactive maintenance model in scenario B. In Table 6.4 we show which event corresponds to which number.

Lastly we will discuss the actions made by the Proactive model in scenario B. We have seen that the total and CAPEX costs of this model are high in Scenario B. In order to understand why this happens we created a timeline of Scenario B where the actions of the Capacity 450 model and the Proactive model are shown. We see that the Proactive model adds a cable at 13.5 years. This is after the big increase

of production power. This means that in the simulation we only have an increase of consumption power with approximately 10 percent in 15 years. However in in equation 6.1 we assume an increase of 15 percent in 15 years. Therefore the Proactive model believes that it is worthwhile to add a new cable at this time, whereas in reality it is not. This illustrates that it is important to have a good estimation on the development of the input powers because otherwise bad decisions can be made. When the cable is added optimally the total costs of the Proactive model in scenario B equals the total costs of the Capacity 550 model with a lower amount of failures. So with correct input expectations the Proactive model has the shortest return on investment time for adding cables and reduces the number of failures with low CAPEX costs. However the previous example shows that we should be careful with modeling expectations for the future.

Chapter 7

Conclusions and Further Research

7.1 Conclusions

In this thesis we investigated the following question:

1. How can we use temperature and current measurements at joints in the distribution grid to determine maintenance actions and what are the effects on the operating expenses (OPEX) and capital expenses (CAPEX) for the DSO and the number of failures in the distribution grid in the situation of Westland Infra?

We also defined six sub-questions to elaborate on the main research question.

1. What is the power grid, how has it evolved in the past and what are the biggest challenges in the near future?
2. How does a DSO operate the distribution grid and which challenges occurred in the grid of Westland Infra?
3. Can we propose a simple mathematical model of the distribution grid that is accurate enough for simulating the effect of the managerial decisions on the grid?
5. Can we propose a proactive maintenance model based on measurements in the grid and how can we model the existing reactive maintenance methods at Westland Infra?
6. Can we find and evaluate the effect of the different maintenance models on the OPEX and CAPEX costs in the distribution grid and the number of failures in the situation of Westland Infra?

For every question we have used a Chapter to examine and answer the question. We will now summarize the conclusions and remarks of every question.

In Chapter 2 we discussed the history, present and future of the power grid. We have seen that major transitions occurred in the beginning of the power grid. First the grid shifted from gas to electricity and later from DC to AC power. In both cases the transitions emerged from changing demands of the customers. We see that these demands are met by technical enhancements and the transition was made when the gains of the enhancements outweighed the costs of implementing the new technology. In the near future we expect that the demands of customers change again and that the power grid needs to be able to meet clean energy demands. The most important enhancements are expected to be more clean energy production, customer participation, two way flows, and new security measures. These are already implemented in some cases but in most cases their gains have not outweighed the costs of implementation.

The present power grid is a complex network which is designed to transport power from large producers to the consumer. The current grid has a lot of centralized production and some decentralized producers. The power flows in a grid are complex and hard to model. One needs to take care of real

and reactive power, voltage and current angles, the power factor of components, three phase power lines and several other physical properties. Besides the power flows the grid also has a complex operational structure. Different operators are responsible for different parts of the grid and they all need to cooperate to ensure balance and security. With a reasonable high amount of power and large fluctuations, the distribution grid is one of the hardest parts of the power grid to operate.

Chapter 3 discussed the distribution system operator and the specific case of Westland Infra. A general DSO makes decisions based on a risk assessment. This assessment is made on economic and technical goals. The costs under consideration are separated as OPEX and CAPEX. The current technical information of the grid is extracted from the SCADA system. The 'easy' structure of the current grid makes it possible for the DSO to use standard 'rules of thumb' when making maintenance strategies. In the grid of Westland Infra however we see that the SCADA system mostly leads to reactive maintenance policies where the DSO takes action after a failure occurs. A proactive policy would be able to prevent these failures but it is unclear if the gains will outweigh the investment costs.

Westland Infra is a DSO with a grid between Rotterdam and The Hague. We consider the grid of Westland Infra as a grid of the future because we see several challenges on distributed generation already emerging in this grid. We considered two main challenges in their grid. Firstly we consider fast degradation and melting of joint insulation because of corrosion and high power flows. Secondly we noted that the high power flows induce high power losses. The total costs of power losses in the grid of Westland Infra are approximately 3 million per year. Though it is unclear when extra maintenance to decrease power losses is worthwhile. If a proactive method can solve both challenges it may be worth implementing.

We presented a model of the distribution grid in Chapter 4. This model made use of the AC Power flow equations. We also modeled the failures in the power grid where we especially focused on failures due to thermal aging and melting of the insulation. We also paid special attention to modeling the CAPEX of maintaining joints and cables and the OPEX induced by power losses. We believe that we have modeled enough physical processes to achieve a good accuracy for our purpose and that we kept the computation time limited.

In Chapter 5 we presented the possibilities emerging from measuring current and temperature at cable joints. We have shown that we can deduce power losses, corrosion, thermal age and input powers from these measurements. We also modeled two maintenance policies based on maintenance rules at Westland Infra. These policies take action when a certain current limit is exceeded. Furthermore we presented a proactive maintenance model. This model optimizes the total expected costs and total expected number of failures in the grid in a predefined timeframe. We approximated these expectation values using a stochastic power flow approach. The model does not account for possible future actions and may therefore induce too many actions during a simulation period.

In Chapter 6 we have shown results of simulations on a part of the grid of Westland Infra. Over the entire simulation period the Capacity 450 method benefits of adding cables early and generates the lowest total costs. The Capacity 550 method has good performance on costs but has to deal with more failures due to joints melting. Lastly the Proactive method has the lowest return on investment times, the most money earned in 15 years after adding a cable and the lowest number of failures. However we see that the expected input powers can have a great impact on the results of this method. In Scenario B the expected input power were a lot higher than the actual input powers and therefore the Proactive model added new cables when it was not beneficial.

With the results of all the Chapters we can analyze our main research question. We have seen that we can use the sensors at joints in different ways and we have shown the effects on the costs and number of failures for a proactive maintenance model. This leads us to the following statements on measuring temperature and current in the distribution grid:

- When we measure temperature and current we are able to determine the power losses in the cable. Including these power losses in the total costs of a grid decreases the return on investment time for adding new cables. This does mean that we have to be able to decrease the OPEX budget and increase the CAPEX budget.
- By using temperature measurements we can see when a joint is going to melt. We can then take

action before an actual outage. This means that temperature measurements on joints can reduce outages at customers.

- We can keep track on the thermal age of components by measuring both temperature and current at the joints. We can use this information to provide better maintenance on these components and reduce outages due to thermal aging.
- Using the data from the sensors we can calculate the input powers in the residual grid. This is even possible when we are not considering a 'smart' grid.
- In an overload situation proactive maintenance has the shortest return on investment time and the highest money gain in the years after adding a cable.

7.2 Further Research

In this study we have interviewed power grid professionals at Westland Infra, studied power grid literature and we developed models of the power grid and maintenance actions. This has created enough insight to realize that the research is not done after this thesis. In this section we will summarize some theoretical and practical ideas for further research.

Theoretical:

- Modeling of customer behavior. The modeling of customer behavior has two goals. First it can be used to expand the simulation and make us able to further analyze the impact of outages. We can also improve the modeling of input powers. Then we can use this to add accuracy to the simulation algorithm. Secondly we need to gain a better understanding of the customers connected to the grid to create better maintenance models. We have seen that wrong assumptions on customer behavior can lead to bad decisions. Therefore we need to be able to generate better expectation values of the input powers.
- Development of 'rules of thumb' for proactive maintenance. Our model for proactive maintenance has an extensive background and we can not see easily when an action should be taken without running the model. For DSO's it is important to develop some easy 'rules of thumb' through which they can make fast decisions based on a specific set of parameters. The following questions could be asked: Which parameters are important in making a proactive maintenance decision? When do we consider a cable overloaded when we consider the entire load profile instead of the peak current?
- Placement of sensors. In this thesis we have assumed that the sensors are present at every joint. In practice however this is not the optimal situation. Placing sensors add extra OPEX and CAPEX and it is hard to place them on existing joints. Developing a model that finds weak cables and joints to place sensors can save costs and ensure better use of the sensors.
- Simulation of overdimensioned grids. In this thesis we have simulated grids in overload situations. However there are some DSO's that believe in overdimensioned grids (e.g. maximum load is 30 percent of capacity). We believe that adding cables to ensure this load induces high return on investment times. Therefore it would also be beneficial to simulate the effects of proactive maintenance on overdimensioned grids. Some possible questions are: What are the benefits and the disadvantages of operating an overdimensioned grid? Can we give an optimal load given the shape of the load profile?

Practical:

- Testing theory of melting and thermal aging. We have developed theoretic equations for the temperature development in a joint and thermal aging of components. By placing temperature and current sensors in a test set-up we would be able to confirm and improve our theoretical results.

- 'Real life' use of the sensors. Besides placing sensors in a test set-up for checking temperature equations we should also test the sensors in real life situations. There are several questions we could answer with such a real life set-up. Which data can we realistically retrieve? How can we efficiently develop and place these sensors? How can we continuously communicate with the sensors?

As can be seen from this section on further research there are still several challenges before the use of sensors in the distribution grid can be realized. We have proposed a simple model which already shows some complexity problems and we have seen where we need to improve the accuracy. Also some practical work needs to be done to develop viable temperature and current sensors. We hope that this thesis in combination with the ideas on further research serve as a motivation for new research projects.

Bibliography

- [1] CRO Forum, *Power Blackout Risks Risk Management Options Emerging Risk Initiative - Position Paper*, November 2011.
- [2] Netbeheer Nederland, www.netbeheernederland.nl.
- [3] National Gas Museum, Leicester, United Kingdom.
- [4] TenneT, www.tennet.nl.
- [5] The Office of Electricity Delivery and Energy Reliability, www.energy.gov.
- [6] Federal Energy Regulatory Commission, www.ferc.gov.
- [7] Westland Infra, *Kwaliteits- en capaciteitsdocument Elektriciteit*, 2011.
- [8] Enexis, *Kwaliteits- en capaciteitsdocument Elektriciteit 2012-2021*, 2012.
- [9] Liander, *Kwaliteits- en capaciteitsdocument Elektriciteit 2011*, 2011.
- [10] Energiekamer NMA, *Netcode Elektriciteit*, 2013.
- [11] Passey, R., Spooner, T., MacGill, I., Watt, M., Syngellakis, K. (2011). The potential impacts of grid-connected distributed generation and how to address them: A review of technical and non-technical factors. *Energy Policy* 39:6280 - 6290.
- [12] Grond, M. (2011). *Impact of Future Residential Loads on Medium Voltage Networks*. Master Thesis, Technische Universiteit Delft.
- [13] Mittal, M., Kamboj, R., Sehgal, S. (2012). Analytical approaches for Optimal Placement and sizing of Distributed generation in Power System. *IOSR Journal of Electrical and Electronics Engineering* 1(1): 20-30.
- [14] Griffin, T., Tomsovic, K., Secret, D., Law, A. (2000). Placement of Dispersed Generations Systems for Reduced Losses. *Proceedings of the 33rd Hawaii International Conference on System Sciences*.
- [15] Lueken, C., Carvalho, P., Apt, J. (2012). Distribution grid reconfiguration reduces power losses and helps integrate renewables. *Energy Policy* 48:260273.
- [16] Talukdar, B.K., Sinha, A.K., Mukhopadhyaya, S., Bose, A. (2005). A computationally simple method for cost-efficient generation rescheduling and load shedding for congestion management. *Electrical Power and Energy Systems* 27: 379-388.
- [17] Kumar, A., Srivastava, S.C., Singh, S.C. (2004). A zonal congestion management approach using ac transmission congestion distribution factors. *Electric Power Systems Research* 72: 85-93.
- [18] Tuan, L.A., Bhattacharya, K., Daalder, J. (2005). Transmission congestion management in bilateral markets: An interruptible load auction solution. *Electric Power Systems Research* 74: 379-389.
- [19] Sood, Y.R., Singh, R. (2010). Optimal model of congestion management in deregulated environment of power sector with promotion of renewable energy sources. *Renewable Energy* 35: 18281836.

- [20] Xiao, Y., Wang, P., Goelb, L. (2009). Congestion management in hybrid power markets. *Electric Power Systems Research* 79: 1416-1423.
- [21] Cardenas, J., Gemoets, L., Rosas, J.A., Sarfi, R. (2013). A literature survey on Smart Grid distribution: an analytical approach. *Journal of Cleaner Production*.
- [22] DNV KEMA, *Utility of the future pulse survey*, 2014.
- [23] Nexans, *6-36kV Medium Voltage Underground Power Cables, XLPE insulated cables*.
- [24] Tyco Electronics, *Raychem Heat-shrinkable Joint Sleeve Rayfit for Medium Voltage Joints up to 36 kV*.
- [25] Neher, J.H., McGrath, M.H. (1957). The Calculation of the Temperature Rise and Load Capability of Cable Systems. *AIEE Transactions Part III* 76: 752-772.
- [26] Westland Infra, *Factsheet Kwaliteit 2011*, 2011.
- [27] KEMA, *Onderzoek naar de methodologie voor de verdeling van de kosten van netverliezen*, 2011.
- [28] Idema, R. (2012). *Newton-Krylov Methods in Power Flow and Contingency Analysis*. Doctoral Dissertation, Technische Universiteit Delft.
- [29] T.J. Overbye (1994). A Power Flow Measure For Unsolvable Cases, *IEEE Transactions on Power Systems* 9:1359-1365.
- [30] Zimmerman, R., Murillo-Sánchez, C., and Thomas, R. (2011). Matpower: Steady-state operations, planning, and analysis tools for power systems research and education. *Power Systems, IEEE Transactions on* 26(1):12-19.
- [31] Anghel, M., Werley, K.A., Motter, A.E. (2007). Stochastic Model for Power Grid Dynamics. *Fortieth Hawaii International Conference on System Sciences*.
- [32] Moon, J.F., Kim, J.C., Lee, H.T., Lee, S.S., Yoon, Y.T., Song, K.B. (2006). Time-varying failure rate extraction in electric power distribution equipment. *9th International Conference on Probabilistic Methods Applied to Power Systems*.
- [33] Mehairjan, R. (2010). *Application of Statistical Life Data Analysis for Cable Joints in MV Distribution Networks*. Master Thesis, Technische Universiteit Delft.
- [34] H. S. Carslaw and J. C. Jaeger (1959). *Conduction of Heat in Solids*, 2nd edition. Oxford University Press.
- [35] Karahan, M., Kalenderli, O. (2011). Coupled Electrical and Thermal Analysis of Power Cables Using Finite Element Method. *Heat Transfer - Engineering Applications*.
- [36] Willis, L., Garrod, G. (1997). Electricity supply reliability: Estimating the value of lost load. *Energy Policy* 25(1): 9-103.
- [37] Caramia, P., Carpinelli, G., Varilone, P., Verde, P., (1999). Probabilistic three-phase load Flow. *Electrical Power and Energy Systems* 21:55-69.
- [38] Centraal Bureau voor de Statistiek, *Elektriciteit; productie en productiemiddelen*, 2013.